



MTX-IND TERMINAL

User Manual



INDUSTRIAL FEATURED GSM/GPRS TERMINAL



Powered by CINTERION WM TC65i GSM-GPRS Wireless Module

General Notes

Product is deemed accepted by recipient and is provided without interface to recipient's products. The documentation and/or product are provided for testing, evaluation, integration and information purposes. The documentation and/or product are provided on an "as is" basis only and may contain deficiencies or inadequacies. The documentation and/or product are provided without warranty of any kind, express or implied. To the maximum extent permitted by applicable law, Matrix Electronica further disclaims all warranties; including without limitation any implied warranties of merchantability, completeness, fitness for a particular purpose and non-infringement of third-party rights. The entire risk arising out of the use or performance of the product and documentation remains with recipient. This product is not intended for use in life support appliances, devices or systems where a malfunction of the product can reasonably be expected to result in personal injury. Applications incorporating the described product must be designed to be in accordance with the technical specifications provided in these guidelines. Failure to comply with any of the required procedures can result in malfunctions or serious discrepancies in results.

Furthermore, all safety instructions regarding the use of mobile technical systems, including GSM products, which also apply to cellular phones, must be followed. Matrix Electronica or its suppliers shall, regardless of any legal theory upon which the claim is based, not be liable for any consequential, incidental, direct, indirect, punitive or other damages whatsoever (including, without limitation, damages for loss of business profits, business interruption, loss of business information or data, or other pecuniary loss) arising out of the use of or inability to use the documentation and/or product, even if Matrix Electronica has been advised of the possibility of such damages. The foregoing limitations of liability shall not apply in case of mandatory liability, e.g. under the Spanish Product Liability Act, in case of intent, gross negligence, injury of life, body or health, or breach of a condition which goes to the root of the contract. However, claims for damages arising from a breach of a condition, which goes to the root of the contract, shall be limited to the foreseeable damage, which is intrinsic to the contract, unless caused by intent or gross negligence or based on liability for injury of life, body or health. The above provision does not imply a change on the burden of proof to the detriment of the recipient. Subject to change without notice at any time. The interpretation of this general note shall be governed and construed according to Spanish law without reference to any other substantive law.

Important information

This technical description contains important information for start up and use of the MTX-IND Terminal. Read it carefully before you start working with the MTX-IND Terminal.

The warranty will be void should damage occur due to non-compliance with these instructions for use. We cannot accept any responsibility for consequential loss.

Service and Support

To contact customer support please use the contact details below:

Matrix Electronica
Alejandro Sanchez, 109
28019 Madrid –Spain-
gsm-support@matrix.es

Information about MTX-IND product and accessories is available on the following web site:

<http://www.matrix.es/MTX-Terminals>

And following FTP server (ask for user&password access):

<ftp://ftp.matrixelectronica.eu/>

Or contact your local distributor / sales agent:

REVISION INFORMATION

FIRST EDITION. VERSION 1.0.
SECOND REVISION VERSION 1.2

Oct 2009

Jul 2010

1. INTRODUCTION	5
1.1 Description	5
1.2. ORDERING INFORMATION	5
Firmware revision TC65i: 01.1001.3 Highlights	5
1.3 Highlights	6
1.3 MTX-IND Wireless modems in a Communication System	8
1.4 Main Features and Services	8
1.4.1 Types of Mobile Station	8
1.4.2 Short Message Service	9
1.4.3 Voice Calls	9
1.4.4 Data	9
1.4.5 GPRS Multi-Slot Support	10
1.4.6 Power Consumption	10
1.4.7 SIM Card	12
1.5 Precautions	12
2. Mechanical Description	12
2.1. Dimensions	12
3. Electrical Description	14
3.1 Power	15
3.2 Relay Contacts	16
3.3 Mini USB Connector	16
3.4 Antenna Connector	17
3.5. SIM card reader	17
3.6 MAIN Serial Interface Port ASC0 RS232/RS485/RS422	18
3.7. SECONDARY SERIAL INTERFACE ASC1	21
3.7.2. I2C Serial Control Bus	23
3.7.3. SPI Bus	24
3.7.4. General Purpose IO	26
3.7.5. Analog-to-Digital Converter (ADC)	28
3.7.6 Real Time Clock	29
3.7.7 DAC / PWM	29
3.8. Software Updates	30
4. Operation	31
4.1 Switching On the Modem	31
4.2 Switching Off the Modem	31
4.3. Automatic restart after shutdown:	31
4.4 Operating States/LED	31
5. Embedded Applications.	32
6 Safety and Product Care	34
6.1. Safety instructions	34
6.2. General precautions	34
6.3. SIM card precautions	34
6.4. Antenna precautions	35
6.5. Radio Frequency (RF) exposure and SAR	35
6.6. Personal Medical Devices	35
7. Installation of the modem	36
7.1 Where to install the modem	36
7.1.1 Environmental conditions	36
7.1.2 Signal strength	36
7.1.3 Connections of components to MTX-IND Terminal	36
7.1.4 Network and Subscription	36
7.2 How to install the modem	36
7.2.1 Power supply	36
7.2.2 Securing the modem	37
7.3 Antenna	37
7.3.1 General	37
7.3.2 Antenna type	37
7.3.3 Antenna placement	37

7.3.4 The antenna cable	37
7.3.5 Possible communications disturbances.....	38
8. Accessories	39
8.1. POWER SUPPLY	39
8.1.2 DC cable	39
8.2. ANTENNAS	40
8.2.1 Magnetic Dual Band Antenna (900/1800MHz).....	40
8.2.2 Right angle short antenna	40
8.2.3 Patch Adhesive Antenna.....	40
8.3. CABLES	41
8.3.2 USB CABLE	41
8.4. DEVELOPMENT KITS.....	41
9, CONFORMITY ASSESSMENT	42
10. RoHs statement.....	44
11. Disposal of old Electrical & Electronic Equipment (WEEE Mark)	44
12. Abbreviations	45
13. AT Command Summary.....	46
15. SALES CONTACT	53

1. INTRODUCTION

1.1 Description

The MTX-IND is a GSM-GPRS terminal modem based on the Cinterion TC65i module with many features to suit industrial environments.

The MTX-IND is the perfect choice for applications that are placed in DIN racks, have a DC or AC power supply, need to control high loads and communicate with the RS232-RS422-RS485 serial bus.

MTX-IND has 4 1C type relays capable to switch up to 6Amp loads. They're connected to 4 GPIOs and can be controlled by AT commands or the JAVA embedded program. There are another 4 TTL/CMOS **input** GPIO and 2 optoisolated differential inputs/outputs.

The MTX-IND has Java embedded programmability and a full range of I/Os. The unit can host and control your Java J2ME application allowing you to develop and embed your code directly inside, shortening time to market and reducing costs. The new internal Watchdog supervisor avoids hang-ups. Alternatively, it can be used as a powerful standalone GPRS modem with its intrinsic TCP/IP stack.

The MTX-IND terminal is able to handle Data calls, SMS, Fax and GPRS connections with its powerful TCP-IP stack communication and Internet Services: TCP, UDP, HTTP, FTP, SMTP, POP3.

With quad band 900/1800 MHz and 850/1900 MHz, your applications can be used all over the world.

MTX-IND is RoHs, WEEE, FCC and CE compliant. It is manufactured with the ISO 9001 & ISO 14001 Quality certifications.

A full list of antennas, cables, supplies and accessories are available.

The MTX-IND incorporates a Cinterion WM TC65i module.

Note! Some of the functions described inside this Technical Description are only possible when the SIM-Card is inserted

1.2. ORDERING INFORMATION

MTX-IND: 199.801.103

Hardware revision: 1.02

Firmware revision TC65i: 01.100

1.3 Highlights

Interfaces

- FME M 50 Ohm antenna connector
- Mini USB (2.0 Full-Speed End-Point Compliant)
- 2 Operating status LED
- SIM card interface 3V, 1.8V with SIM detection
- Plug-in power supply and on/off interfaces
- 52 pluggable terminals 5,00 pitch:
 - Configurable RS232/RS485/RS422
 - Optoisolated inputs (IN10, IN9, IN8, and IN4).
 - 2 Optoisolated input/output (IO5 e IO6)
 - 4 Outputs connected to 1P1C relays.
 - 2 Analog Inputs (0-2.4V or 4-20mA configurable)
 - 1 Digital Analog Output (PWM) / DAC
Digital-to-Analog Converter which can provide a PWM signal.
 - 1 x I2C/SPI bus
 - Power supply 12-24 VAC or 12-30 VDC, (not needed to select polarity or type)

General Features

- Quad-Band GSM 850/900/1800/1900 MHz
- GPRS multi-slot class 12
- GSM release 99
- Output power:
 - Class 4 (2 W) for EGSM850 & EGSM900
 - Class 1 (1 W) for GSM1800 & GSM1900
- Control via AT commands (Hayes 3GPP TS 27.007 and 27.005)
- SIM Application Toolkit (release 99)
- TCP/IP stack access via AT commands
- Internet Services: TCP, UDP, HTTP, FTP, SMTP, POP3
- Supply voltage range: 12-24 VAC or 12-30 VDC
- Power consumption (at 7.2 V): (with relays OFF)
 - Power down 0,5 mA
 - Sleep mode (registered DRX = 2) 28 mA
 - Speech mode (average) 360 mA
 - GPRS class 12 [Power reduction = 6dB] (average) 330 mA
- Temperature range
 - Operation: -10°C to +70°C
 - Storage: -40°C to +85°C
- Dimensions. Excluding connectors: 157 x 86 x 58mm
- Weight: < 300g

GPRS data transmission

- GPRS class 12
- Mobile station class B
- PBCCH support
- Coding schemes CS 1-4

Multiple simultaneous PDP contexts

CSD data transmission

- Up to 14.4 Kbit/s
- V.110
- Non-transparent mode
- USSD support

Specification for fax

Group 3, class 1, 2

Voice Features (upon request)

- Triple-rate codec for HR, FR, and EFR
- Adaptive multi-rate AMR
- Basic hands-free operation
- Echo cancellation
- Noise reduction

Short Message Service (SMS) Features

- Point-to-point MO and MT
- SMS cell broadcast
- Text and PDU mode

Internet Protocols

TCP/UDP/IP protocol stack

Extensive AT command access to TCP/IP stack

Internet Services: TCP, UDP, HTTP, FTP, SMTP, POP3

Open application resources

ARM© Core, Blackfin© DSP

- Memory: 400 KB (RAM) and 1.7 MB (Flash)
- Improved power-saving mode

Java™ features

- CLDC 1.1 HI
- J2ME™ profile IMP-NG
- Secure data transmission with HTTPS, SSL and PKI

Over-the-air update

- Application SW: OTAP
- Firmware: FOTA (OMA compliant)

1.3 MTX-IND Wireless modems in a Communication System

Figure 1 and Figure 2 illustrate the main blocks of a wireless communication system using the wireless modem. Figure 1 shows the communication system when a micro-controller is used. They also show the communication principles of the system and the interface between the wireless modem and the application. Figure 2 shows the communication system when the JAVA application is embedded on the wireless modem. The definitions in the figures, as used elsewhere in this manual, are in accordance with the recommendations of 3GPP TS 27.007.

The MS (mobile station) represents the wireless modem and SIM card. The wireless modem excluding SIM card, is known as the ME (mobile equipment).

The DTE (data terminal equipment) is the controlling application. This can be either an external host or an internal embedded application.

The DCE (data circuit terminating equipment) is the serial communication interface of the MS.

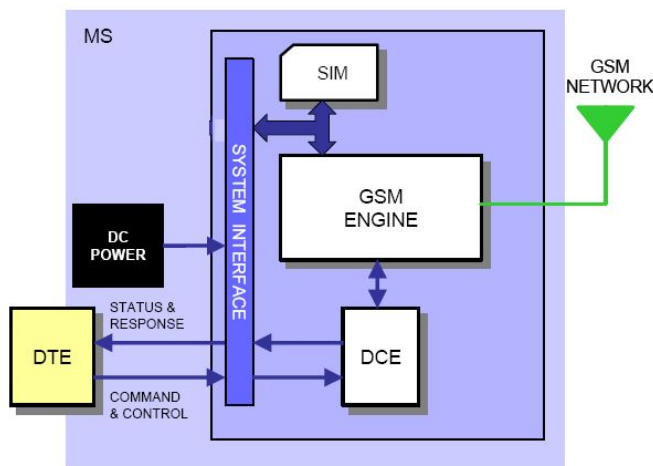

Figure 1. Main Blocks in a Wireless System (external micro-controller)

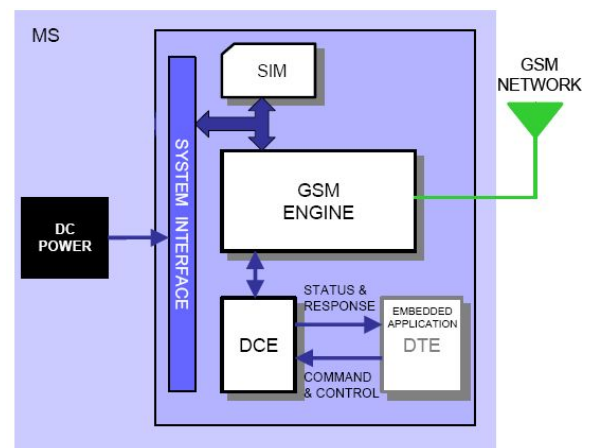

Figure 2. Main Blocks in a Wireless System (embedded application)

1.4 Main Features and Services

The MTX-IND performs a set of telecom services (TS) according to GSM standard phase 2+, ETSI and ITU-T. The services and functions of the MTX-IND are implemented by issuing customized applications embedded on the device, by AT commands issued internally or over the RS232 serial interface.

1.4.1 Types of Mobile Station

The MTX-IND is a fully Quad Band capable GSM/GPRS mobile station with the characteristics shown in the table below:

Feature		GSM850	E-GSM900	GSM1800	GSM1900
Frequency range (MHz)	Tx	824-849	880-915	1710-1785	1850-1910
	Rx	869-894	925-960	1805-1880	1930-1990
RF power @ARP with 50Ω load (typ)		33dBm	33dBm	30dBm	30dBm
Channel spacing		200kHz	200kHz	200kHz	200kHz
Number of channels		124	174	374	299
Number of TD slots		8	8	8	8
Duplex spacing		45MHz	45MHz	95MHz	80MHz
GSM power class		4 (2W)	4 (2W)	1 (1W)	1 (1W)
Modulation		GMSK			
Receive sensitivity		<-102dBm at antenna connector			
GPRS multi-slot class		Class 12			

1.4.2 Short Message Service

The wireless modem supports the following SMS services:

- Sending; MO (mobile-originated) with both PDU (protocol data unit) and text mode supported.
- Receiving; MT (mobile-terminated) with both PDU and text mode supported.
- CBM (cell broadcast message); a service in which a message is sent to all subscribers located in one or more specific cells in the GSM network (for example, traffic reports).
- SMS status report according to 3GPP TS 23.40.

The maximum length of a text mode SMS message is 160 characters using 7-bit encoding. The wireless modem supports up to six concatenated messages to extend this function. Concatenation is performed by the host application.

1.4.3 Voice Calls

The wireless modem offers the capability of MO (mobile originated) and MT (mobile terminated) voice calls, as well as supporting emergency calls. Multi-party, call waiting and call divert features are available. Some of these features are network operator specific.

For the inter-connection of audio, the wireless modem offers balanced analogue input and output lines. The wireless modems support HR, FR, EFR and AMR vocoders.

1.4.4 Data

The wireless modem supports the following data protocols:

- GPRS (General Packet Radio Service)

The wireless modem is a Class B terminal. The wireless modem is GPRS multi-slot class 12 enabled, capable of receiving at a maximum of four timeslots per frame (down link), and transmitting in four timeslots per frame (up link). See section 1.4.5 for multi-slot allocation by class.

- CSD (Circuit Switched Data)

The MTX-IND wireless modem is capable of establishing a CSD communication at 9.6 kbps over the air.

1.4.5 GPRS Multi-Slot Support

GSM Multi-slot classes supported by MTX-IND

Multi-slot Class	Maximum slot allocation			Allowable Configuration	Max data rate
	Downlink	Uplink	Active		
8	4	1	5	1 up; 4 down	8-12Kbps Send 32-48Kbps Receive
10	4	2	5	1 up; 4 down	8-12Kbps Send 32-48Kbps Receive
				2 up; 3 down	16-24Kbps Send 24-36Kbps Receive
12	4	4	5	1 up 4 down 2 up 3 down 3 up 2 down 4 up 1 down	8-12kpbs per slot

1.4.6 Power Consumption

The table below briefly summarizes the various operating modes referred to in the following chapters.

Normal operation	GSM / GPRS SLEEP	Various power save modes set with AT+CFUN command. Software is active to minimum extent. If the Terminal was registered to the GSM network in IDLE mode, it is registered and paging with the BTS in SLEEP mode, too. Power saving can be chosen at different levels: The NON-CYCLIC SLEEP mode (AT+CFUN=0) disables the AT interface. The CYCLIC SLEEP modes AT+CFUN=7 and 9 alternately activate and deactivate the AT interfaces to allow permanent access to all AT commands.
	GSM IDLE	Software is active. Once registered to the GSM network paging with BTS is carried out. The Terminal is ready to send and receive.
	GSM TALK	Connection between two subscribers is in progress. Power consumption depends on network coverage individual settings, such as DTX off/on, FR/EFR/HR, hopping sequences, antenna.
	GPRS IDLE	Terminal is ready for GPRS data transfer, but no data is currently sent or received. Power consumption depends on network settings and GPRS configuration (e.g. multi-slot settings).
	GPRS DATA	GPRS data transfer in progress. Power consumption depends on network settings (e.g. power control level), uplink / downlink data rates, GPRS configuration (e.g. used multi-slot settings) and reduction of maximum output power.
ULTRA LOW POWER MODE	Shutdown after sending the AT^SMSO command. The RTC works continuously, but the software is not active. Interfaces are not accessible.	
Airplane mode	Airplane mode shuts down the radio part, causes the Terminal to log off from the GSM/GPRS network and disables all AT commands whose execution requires a radio connection. Airplane mode can be controlled by the AT commands AT^SCFG and AT+CALA: With AT^SCFG= MEopMode/Airplane/OnStart the Terminal can be configured to enter the Airplane mode each time when switched on or reset. The parameter AT^SCFG=MEopMode/Airplane can be used to switch back and forth between Normal mode and Airplane mode any time during operation. Setting an alarm time with AT+CALA followed by AT^SMSO wakes the module up into Airplane mode at the scheduled time.	

Average power consumption

Parameter	Description	Conditions	Min	Typ	Max	Unit
VPOWER	Operating Voltage		6	12	30	V
IPOWER Average supply current (average time 3 min.) @25°C @ worst case: GSM 900 max power level	Low Power mode			50		µA
	Power Down mode (stand by)			NA		mA
	SLEEP mode			29		mA
	IDLE mode			37		mA
	TALK mode			365		mA
Data GPRS 1Tx / 4Rx			173		mA	
Data GPRS 2Tx / 3Rx (Power reduction = 3dB)			248		mA	
Data GPRS 4Tx / 1Rx (Power reduction = 6dB)			330		mA	
IPOWER_P (6)	Peak supply current during transmission slot (577µs * No. of Tx every 4.6ms)	Power control level for Pout max		1600		mA

The power consumption figures shown represent the typical average current and different multi-slot configurations, the worst case being that of two uplink and three downlink slots.

(6) Typical values measured with antenna impedance = 50Ohm (return loss >20dB)

1.4.7 SIM Card

The MTX-IND supports SIM card through the integrated SIM holder. Both 3V and 1.8V SIM technology is supported. Older, 5V SIM technology is not supported.

1.5 Precautions

The MTX-IND as a standalone item is designed for indoor use only. For outdoor use it must be integrated into a weatherproof enclosure.

2. MECHANICAL DESCRIPTION

2.1. Dimensions

Housing Plastic Dimension in mm. External connectors are not included.

With terminal block and FME connector, total dimensions are 167 x 92 x 58mm.

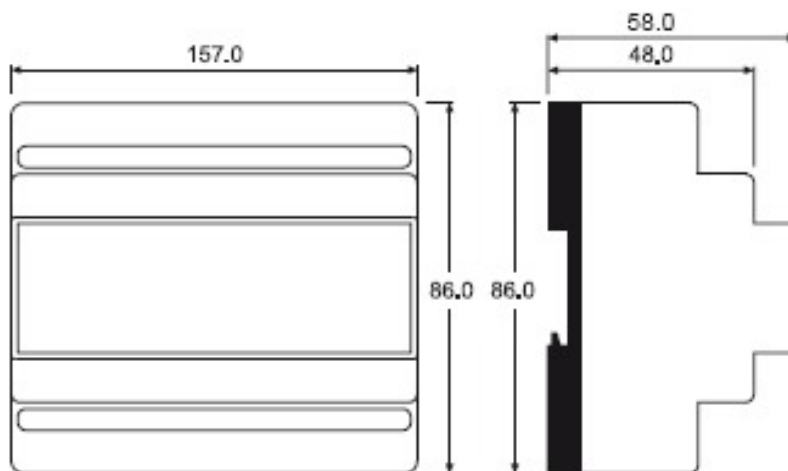

Figure 5. Dimensions of the MTX-IND terminal in mm

Module enclosure for M36 DIN-rail

TOP PART

Material	Lexan 940
Colour	Grey (RAL 7035)
Max. temperature	100°C
Width	157 mm
	9 modules
Self-extinguishing	Acc. To UL94-V0

BASE PART

Material	Noryl VO 1550
Colour	Black (RAL 7021)
Max. temperature	100°C
Max. wire diameter	2 x 2.5 mm ²
Max. load	10A
Terminals	52 pluggable
Mounting	DIN-rail (EN50022)
Self-extinguishing	Acc. To UL94-V0

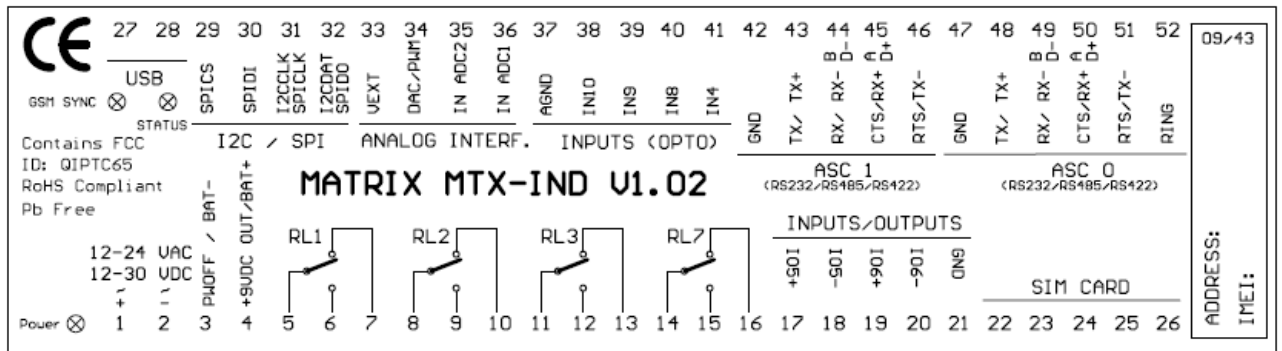

3. ELECTRICAL DESCRIPTION

Block terminal	Default feature	Additional feature	TC65i Connection	Other feature
1	+12Vdc/24Vac	Jumpers		
2	GND/24Vac	Jumpers		
3	POWER OFF			
4	+9Vdc out (max500mA)			
5	RL1 com		GPIO1	
6	RL1 na			
7	RL1 nc			
8	RL2 com		GPIO2	
9	RL2 na			
10	RL2 nc			
11	RL3 com		GPIO3	
12	RL3 na			
13	RL3 nc			
14	RL7 com		GPIO7	
15	RL7 na			
16	RL7 nc			
17	IN5/OUT5 +	IN/OUT	GPIO5	
18	IN5/OUT5 -			
19	IN6/OUT6 +	IN/OUT	GPIO6	
20	IN6/OUT6 -			
21	GND			
22	SIM HOLDER			
23	SIM HOLDER			
24	SIM HOLDER			
25	SIM HOLDER			
26	SIM HOLDER			
27	USB & Sync LED			
28	USB & Status LED		SYNC	
29	SPICS			
30	SPIDI			
31	I2CCLK/SPICLK			
32	I2CDAT/SPIDO			
33	Vext		Vext	
34	OUT DAC / PWM			
35	IN ADC2			
39	IN ADC1			
37	AGND			
38	IN10		GPIO10	
39	IN9		GPIO9	
40	IN8		GPIO8	
41	IN4		GPIO4	
42	GND			
43	RS232 TX / RS485 D+ / RS422 TX+			RS232 DSR
44	RS232 RX / RS422 RX-			RS232 DCD
45	RS232 CTS / RS422 RX			
46	RS232 RTS / RS485 D- / RS422 TX-			RS232 DTR
47	GND			
48	RS232 TX / RS485 D+ / RS422 TX+			VMIC
49	RS232 RX / RS422 RX-			MICP1
50	RS232 CTS / RS422 RX+			MICN1
51	RS232 RTS / RS485 D- / RS422 TX			EPP1
52	RING			EPN1

All electrical connections to the module are protected in compliance with the standard air and contact Electrostatic Discharge (ESD).

3.1 Power

Pin 1 and 2 are used to power MTX-IND. It can be VDC or VAC powered, without needing to configure anything. Just apply the VCC or VAC voltage

The supply voltage, VCC or VAC required by the modem are in the ranges of 12-30 VDC and 12-24VAC. The power supply has to be a single voltage source capable of providing a peak during an active transmission. The uplink burst causes strong ripples (or a drop) on the power lines.

The voltage supply switches the modem on.

Automatic restart after shutdown feature:

This allows an application to always be switched on; it will be able to restart by itself.

The terminal will not need external ignition to be powered up and will be powered up 100% of the time if power is applied.

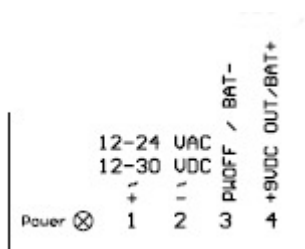

The MTX-IND has an optional feature where it can charge an external 12V Pb battery which needs an external hardware circuit. Ask gsm-support@matrix.es for more information.

Note. VCC and GND are reverse polarity and overvoltage protected

PIN:	Signal	Dir	Limits	Description
1	Positive VCC VAC	Input	12-30 VDC Typ. 24 12-24 VAC	Positive power input
2	Negative VCC VAC	Input	12-30 VDC Typ. 24 12-24 VAC	Negative power input
3	PW OFF /BAT-	Input / Batt -		Power off – Negative battery
4	+9VDC OUT/BAT+	Output /Batt +	Max 0,5 A	+9 VDC

PIN 3. PWOFF: Power Off. It's possible to reset and power-off the terminal connecting this pin to ground.

Note. The input range can be change between 9V and 12V (DC or AC) closing the contacts of the Jx1 Jumper inside.

3.2 Relay Contacts

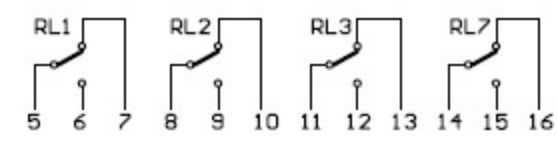

<i>PIN:</i>		<i>Signal</i>	<i>Limits</i>	<i>Description</i>
5	RL1 is controlled by GPIO1 (as output)	Common		Common contact
6		NA		Normally open contact
7		NC		Normally closed contact
8	RL2 is controlled by GPIO2 (as output)	Common		Common contact
9		NA		Normally open contact
10		NC		Normally closed contact
11	RL3 is controlled by GPIO3 (as output)	Common		Common contact
12		NA		Normally open contact
13		NC		Normally closed contact
14	RL7 is controlled by GPIO7 (as output)	Common		Common contact
15		NA		Normally open contact
16		NC		Normally closed contact

Relay used: FTR-LY-CA012Y [click here to download specifications](#)

Coil power consumption 170mW

Rating 6A, 250 VAC / 24 VDC

Maximum Carrying Current 6A

Maximum Switching Power 1,500 VA / 144 W

Maximum Switching Voltage 250 VAC

Minimum Switching Load 100 mA 5 VDC

3.3 Mini USB Connector

MTX-IND supports a USB 2.0 Full Speed (12Mbit/s) device interface. The USB interface is primarily intended for use as a command and data interface and for downloading firmware. The USB I/O pins are capable of driving the signal at min 3.0V. They are 5V I/O compliant.

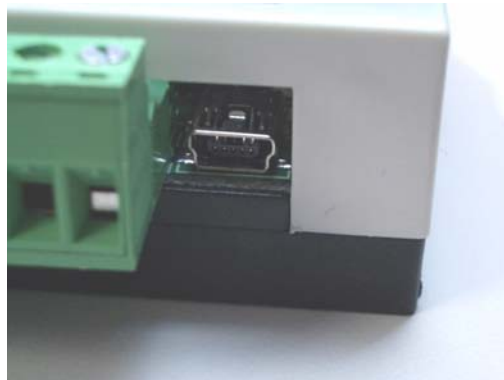

The USB port has different functions depending on whether or not Java is running. Under Java, the lines may be used for debugging purposes. If Java is not used, the USB interface is available as a command and data interface and for downloading firmware.

The USB I/O-pins are capable of driving the signal at min 3.0V. They are 5V I/O compliant. To properly connect the module's

USB interface to the host, a USB 2.0 compatible connector is required. Furthermore, the USB modem driver delivered with the MTX-IND must be installed as described below.

The USB host is responsible for supplying power, across the VUSB_IN line, to the terminal USB interface. There are drivers available for Windows environment applications. Visit the MTX-IND web page at: www.matrix.es/MTX-TERMINALS

3.4 Antenna Connector

The antenna connector allows radio frequency (RF) transmission signals between the modem and an external customer-supplied antenna. The modem is fitted with a 50Ω, FME male coaxial jack.



The external antenna must be matched properly to achieve the best performance regarding radiated power, modulation accuracy and harmonic suppression.

3.5. SIM card reader

The MTX-IND Terminal is fitted with a SIM card reader designed for 1.8V and 3V SIM cards.

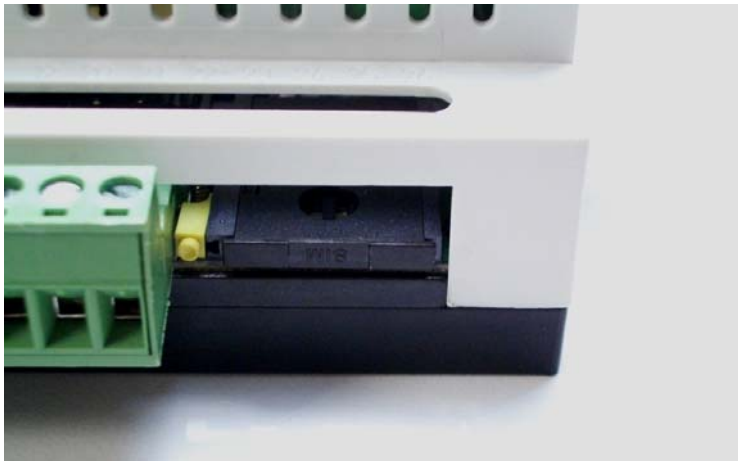

The card holder is a six wire interface according to GSM 11.11. Two pins have been added to detect whether or not the SIM card drawer is inserted.

Removing and inserting the SIM card during operation requires the software to be reinitialized. Therefore, after reinserting the SIM card it is necessary to restart the MTX-IND Terminal.

The MTX-IND relies on a SIM card being inserted in order to be fully operational. Some of the MTX-IND functionality may be lost if you try to operate the control terminal without a SIM card.

3.6 MAIN Serial Interface Port ASC0 RS232/RS485/RS422

The modem by default supports a standard RS232 serial interface (EIA/TIA 574) via following block pins, shown below.

This can be changed to RS485 and RS422 interfaces with internal jumper selectors. RS485 and RS422 can be configured as open bus or ended with 120 ohm resistor.

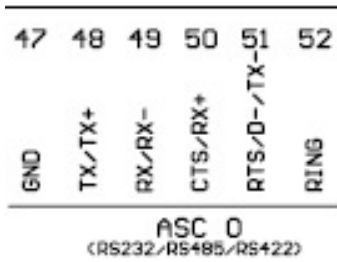

Block pin number	Description
Block pin 47	GND RS232 ASC0
Block pin 48	TX/TX+ RS232/RS485/422 ASC0
Block pin 49	RX/RX- RS232/RS485/422 ASC0
Block pin 50	CTS/RX+ RS232/RS485/422 ASC0
Block pin 51	RTS/TX- RS232/RS485/422 ASC0
Block pin 52	RING ASC0

Internal JUMPER CONFIGURATION

Location for JPC1 & JPC3

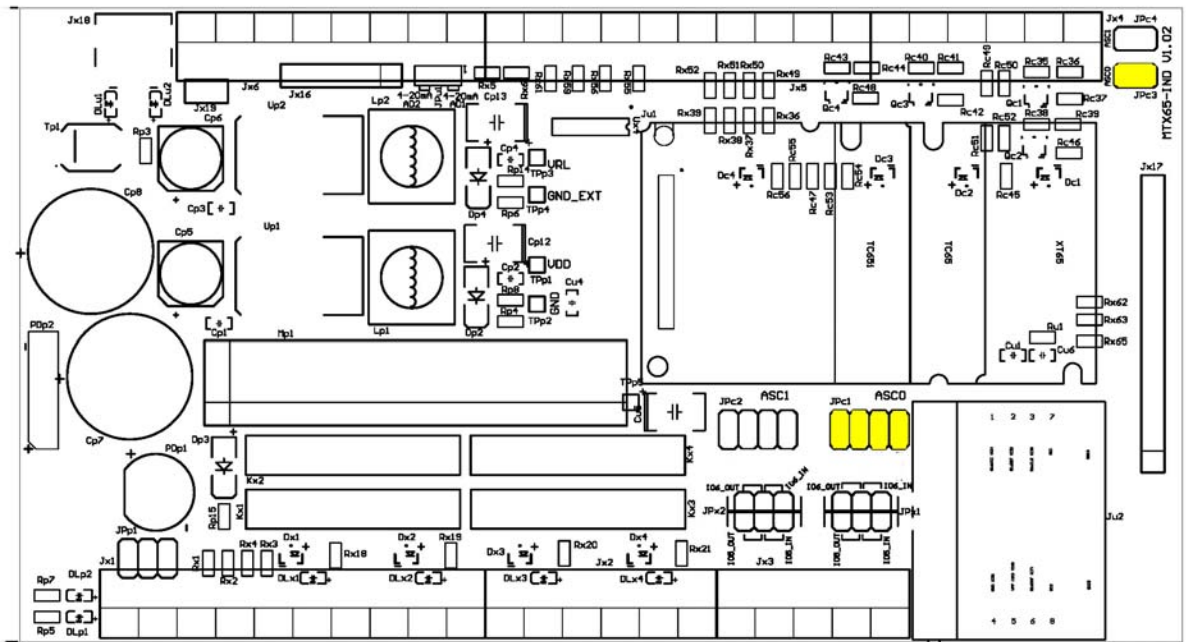

RS-232 (By default)

JPC1

- > JP 1-2 Open
- > JP 3-4 Open
- > JP 5-6 Close
- > JP 7-8 Close

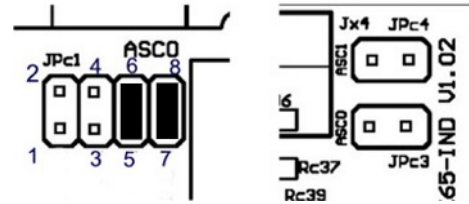

JPC3

- > JP 1-2 Open

RS-485 open bus

JPC1

- > JP 1-2 Open (No Res)
- > JP 3-4 Open
- > JP 5-6 Open
- > JP 7-8 Open

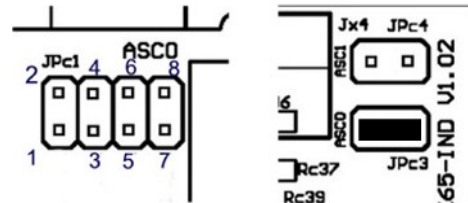

JPC3

- > JP 1-2 Close

RS-485 Bus ended with 120 ohm resistor

JPC1

- > JP 1-2 Close (Res 120)
- > JP 3-4 Open
- > JP 5-6 Open
- > JP 7-8 Open

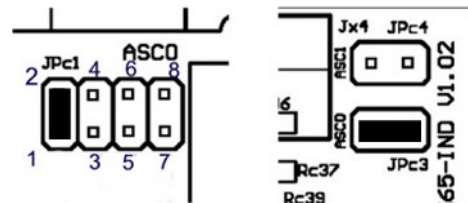

JPC3

- > JP 1-2 Close

RS-422 open bus

JPC1

- > JP 1-2 Open (No Res)
- > JP 3-4 Open (No Res)
- > JP 5-6 Close
- > JP 7-8 Open

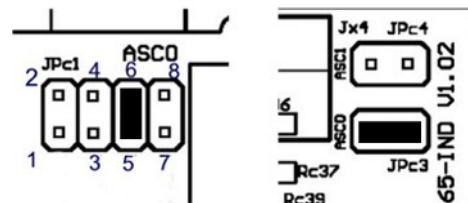

JPC3

- > JP 1-2 Close

RS-422 bus ended with 120 ohm resistor

JPC1

- > JP 1-2 Close (Res 120)
- > JP 3-4 Close (Res 120)
- > JP 5-6 Close
- > JP 7-8 Open

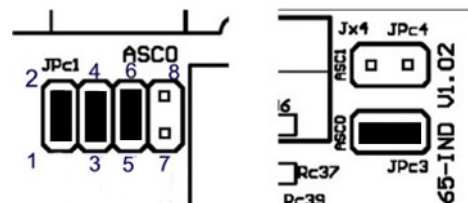

JPC3

- > JP 1-2 Close

RS232 Interface

The MTX-IND Terminal is designed for use as a DCE (data circuit-terminating equipment). Based on the conventions for DCE-DTE connections, it communicates with the customer application (DTE- data terminating equipment) using the following signals:

- Port TxD @ application sends data to TXD of MTX-IND Terminal
- Port RxD @ application receives data from RXD of MTX-IND Terminal

The RS-232 interface is implemented as a serial asynchronous transmitter and receiver conforming to ITU-T V.24 Interchange Circuits DCE.

The electrical characteristics of the RS232 serial port signals are shown below:

Note: Outputs at 3kOhm load

<i>Pin</i>	<i>Signal</i>	<i>Dir</i>	<i>Voltage levels</i>	<i>Description</i>
49	RX	O	Min $\pm 5V$	Received data
48	TX	I	VILmax = 0.6V VIHmin = 2.4V VImax = $\pm 25V$	Transmitted data
47	GND	-	0V	Ground connection
51	RTS	I	VILmax = 0.6V VIHmin = 2.4V VImax = $\pm 25V$	Request to send
50	CTS	O	Min $\pm 5V$	Clear to send
52	RI	O	Optocoupled	Ring indicator

- It includes the data lines TXD0 and RXD0, the status lines RTS0 and CTS0 and also the modem control line RING0.
- ASC0 is primarily designed for controlling voice calls, transferring CSD, fax and GPRS data and for controlling the GSM engine with AT commands.
- Full Multiplex capability allows the interface to be partitioned into three virtual channels, but with CSD and fax services only available on the first logical channel. Please note that when the ASC0 interface runs in Multiplex mode, ASC1 cannot be used.
- The RING0 signal indicates incoming calls and other types of URCs (Unsolicited Result Code). It can also be used to send pulses to the host application, like waking up the application from a power saving state. To configure the RING0 line, use the following AT Command: AT^SCFG.
- By default it is configured for 11500 bps, 8 data bits, no parity and 1 stop bit.
- ASC0 can be operated at fixed bit rates from 300 bps to 460800 bps.
- Autobauding is not compatible with multiplex mode.
- Supports RTS0/CTS0 hardware flow control and XON/XOFF software flow control.

3.7. SECONDARY SERIAL INTERFACE ASC1

The MTX-IND includes a second serial interface ASC1 which can be configured to the RS232, RS485 or RS422 with the following block pins shown below.

The modem supports an RS485 serial interface by default.

This can be changed to RS232 and RS422 interfaces with internal jumper selectors.

RS485 and RS422 buses can be configured as open bus or ended with 120 ohm resistor

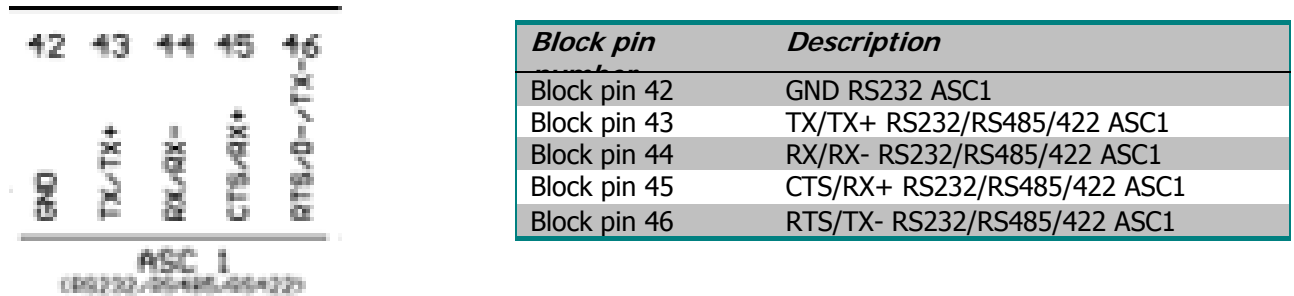

Internal JUMPER CONFIGURATION

Location for JPC2 & JPC4

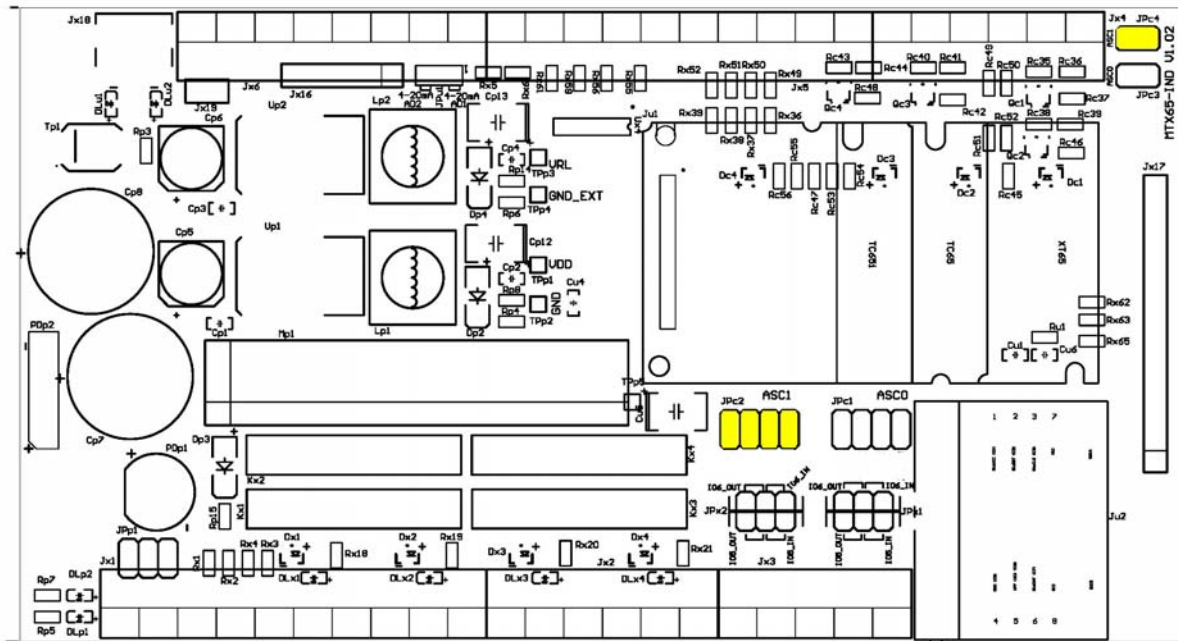

RS-232

JPC2

- > JP 1-2 Open
- > JP 3-4 Open
- > JP 5-6 Close
- > JP 7-8 Close

JPC4

- > JP 1-2 Open

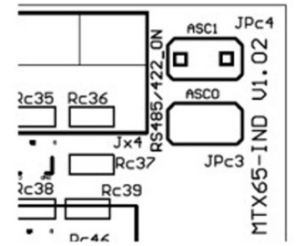
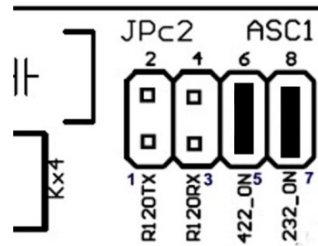

RS-485 open bus

JPC2

- > JP 1-2 Open (No Res)
- > JP 3-4 Open
- > JP 5-6 Open
- > JP 7-8 Open

JPC4

- > JP 1-2 Close

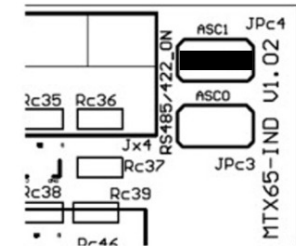
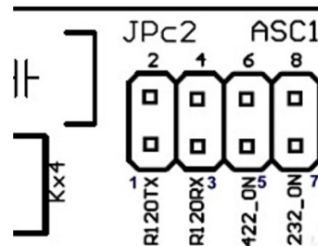

RS-485 Bus ended with 120 ohm resistor

JPC2

- > JP 1-2 Close (Res 120)
- > JP 3-4 Open
- > JP 5-6 Open
- > JP 7-8 Open

JPC4

- > JP 1-2 Close

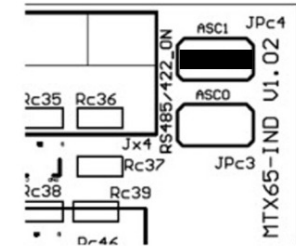
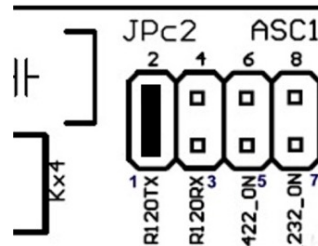

RS-422 open bus

JPC2

- > JP 1-2 Open (No Res)
- > JP 3-4 Open (No Res)
- > JP 5-6 Close
- > JP 7-8 Open

JPC4

- > JP 1-2 Close

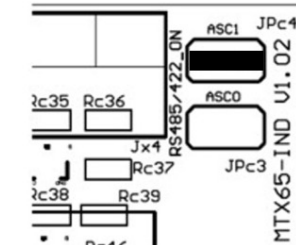
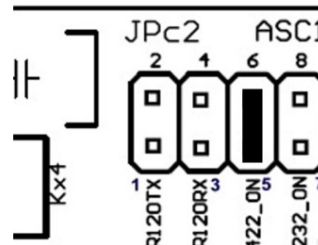

RS-422 Bus ended with 120 ohm resistor

JPC2

- > JP 1-2 Close (Res 120)
- > JP 3-4 Close (Res 120)
- > JP 5-6 Close
- > JP 7-8 Open

JPC4

- > JP 1-2 Close

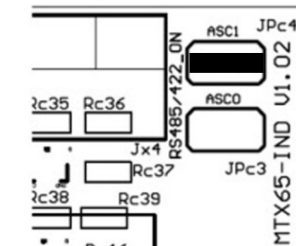
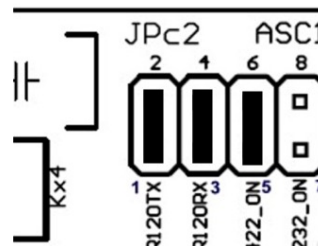

ASC1 RS232

The ASC1 interface is available as a 2-wire unbalanced, asynchronous modem interface ASC1 conforming to ITU-T V.24 protocol DCE signaling.

<i>Pin</i>	<i>Name</i>	<i>Direction</i>		<i>Function</i>
42	GND	-		Ground
43	TX	I	VILmax = 0.6V VIHmin = 2.4V VImax = ±25V	Transmitted data
44	RX	O	Min ±5V	Received data
45	CTS	O	Min ±5V	Clear to send
46	RTS	I	VILmax = 0.6V VIHmin = 2.4V VImax = ±25V	Request to send

RS232 Features

- It includes the data lines TD1 and RD1 and the status lines RTS1 and CTS1. It only supports XON/XOFF software flow control.
- On ASC1 no RING line is available. The indication of URCs on the second interface depends on the settings made with the AT^SCFG command.
- Configured for 8 data bits, no parity and 1 or 2 stop bits.
- ASC1 can be operated at fixed bit rates from 300 bps to 460800 bps. Autobauding is not supported on ASC1. By default it is 115200 bps, 8 bits, no parity and 1 stop bit.

3.7.2. I2C Serial Control Bus

I2C is a serial, 8-bit oriented data transfer bus for bit rates up to 400kbps in Fast mode. It consists of two lines: the serial data line I2CDAT and the serial clock line I2CCLK.

The MTX-IND module acts as a single master device, e.g. the clock I2CCLK is driven by module. I2CDAT is a bi-directional line.

Each device connected to the bus is software addressable by a unique 7-bit address, and simple master/slave relationships exist at all times. The module operates as master-transmitter or as master-receiver. The customer application transmits or receives data only on request of the module.

<i>Pin</i>	<i>MTX-IND Signal</i>	<i>Dir</i>	<i>Max. Voltage limits</i>	<i>Description</i>
31	I2CCLK	O	0.2 - 3.05 V	I2C bus clock signal
32	I2CDAT	I/O	Input: 0.8 - 3.05V Output: 0.2 - 3.05V	I2C data bus
42,47,21	GND		0V	Ground connection

To configure and activate the I2C bus use the AT^SSPI command. If the I2C bus is active, the two lines I2CCLK and I2DAT are locked for use as SPI lines. Vice versa, the activation of the SPI locks both lines for I2C.

The I2C interface is powered from an internal VEXT supply line so the I2C interface will be properly shut down when the module enters the Power-down mode.

29	30	31	32
SPICS	SPIDI	I2CCLK SPICLK	I2CDAT SPIDO
I2C / SPI			

Function	Signal name	IO	Signal form and level	Comment
I2C interface	I2CCLK	O	$RO \approx 33\Omega$ $VOL_{max} = 0.25V$ at $I = 2mA$ $VOH_{min} = 2.50V$ at $I = -0.5mA$ $VOH_{max} = 3.05V$	I2CDAT is configured as pen Drain and needs a pull-up resistor in the host application. According to the I2C Bus Specification Version 2.1 for the fast mode a rise time of max. 300ns is permitted. There is also a maximum $VOL=0.4V$ at 3mA specified. The value of the pull-up depends on the capacitive load of the whole system (I2C Slave + lines). The maximum sink current of I2CDAT and I2CCLK is 4mA. If lines are unused, keep pins open.
	I2CDAT	I/O	$RO \approx 33\Omega$ $VOL_{max} = 0.25V$ at $I = 2mA$ $VIL_{max} = 0.8V$ $VIH_{min} = 2.0V$ $VIH_{max} = 3.05V$	

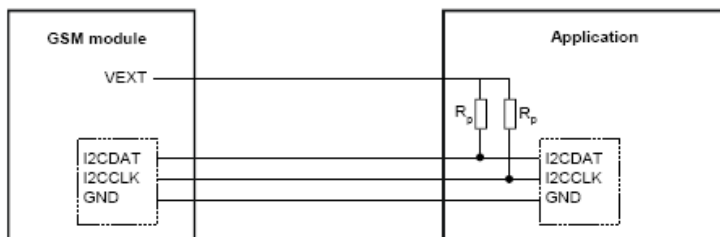

3.7.3. SPI Bus

The SPI (serial peripheral interface) is a synchronous serial interface for control and data transfer between the MTX-IND Terminal and the connected application. Only one application can be connected to the module's SPI. The interface supports transmission rates up to 6.5Mbit/s.

It consists of four lines, the two data lines SPIDI/SPIDO, the clock line SPICLK and the chip select line SPICS.

29	30	31	32
SPICS	SPIDI	I2CCLK SPICLK	I2CDAT SPIDO
I2C / SPI			

Signal name	Terminal block	Description
SPICS	29	Chip select – selects and activates the external device via a low signal.
SPIDI	30	Data in – serial data input line (from the external device to the MTX-IND Terminal)
I2CDAT_SPIDO	32	Data out – serial data output line (from the MTX-IND Terminal to the external device)
I2CCLK_SPICLK	31	Serial clock line

The MTX-IND Terminal acts as a single master device, e.g. the clock SPICLK is driven by module. Whenever the SPICS pin is in a low state, the SPI bus is activated and data can be transferred from the module and vice versa. The SPI interface uses two independent lines for data input (SPIDI) and data output (SPIDO).

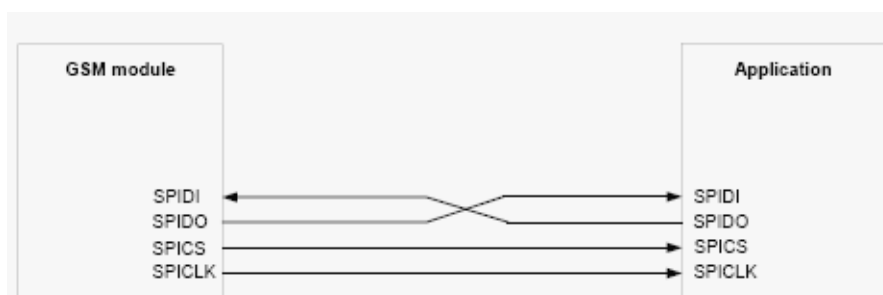

To configure and activate the SPI bus use the AT^SSPI command. If the SPI bus is active, the two lines I2CCLK and I2DAT are locked for use as I2C lines.

In general SPI supports four operation modes. The modes are different in clock phase and clock polarity. The module's SPI mode can be configured by using the AT command AT^SSPI. Make sure the module and the connected slave device works with the same SPI mode.

The following picture shows the characteristics of the four SPI modes. The SPI modes 0 and 3 are the most common used modes.

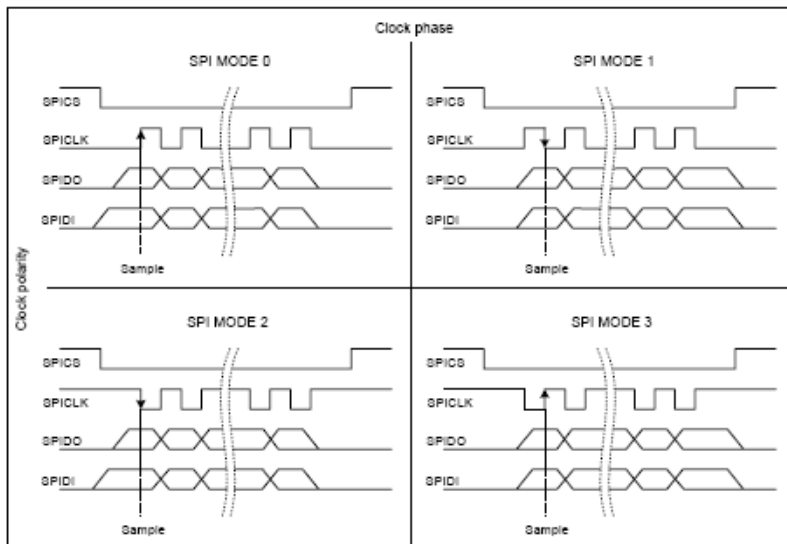

The SPI interface is only available if pins 29 and 30 in the IO interface connector are not used as an I2C interface.

3.7.4. General Purpose IO

INPUTS/OUTPUTS				
IO5+	IO5-	IO6+	IO6-	GND
17	18	19	20	21

Terminal block 17, 18 INPUT/OUTPUT IO5

Terminal Block 17 = IO5+

Terminal Block 18 = IO5-

Optoisolated. This I/O can be configured by JUMPERS as an input or differential output.

If output is configured, open collector type:

IO5+ > Optoisolated Open collector

IO5- > Optoisolated Emitter transistor opto internal

Maximum Voltage at collector - emitter 30V 80mA

If Input configured, it is an optoisolated differential input.

Maximum Voltage IO5+ and IO5- : 30V

Terminal block 19, 20 INPUT/OUTPUT IO6

Terminal Block 19 = IO6+

Terminal Block 20 = IO6-

Optoisolated. This I/O can be configured by JUMPERS as an input or differential output.

If output is configured, open collector type:

IO6+ > Optoisolated Open collector

IO6- > Optoisolated Emitter transistor opto internal

Maximum Voltage at collector - emitter 30V 80mA

If input is configured, it is an optoisolated differential input.

Maximum Voltage IO6+ and IO6- : 30V

Pin	MTX-IND Signal	Dir	Max. Voltage limits	Description
17	IO 5+	I/O		Positive Digital Input/Output 5
18	IO 5-	I/O		Negative Digital Input/Output 5
19	IO 6+	I/O		Positive Digital Input/Output 6
20	IO 6-	I/O		Negative Digital Input/Output 6

Jumper JPx1-JPx2 location

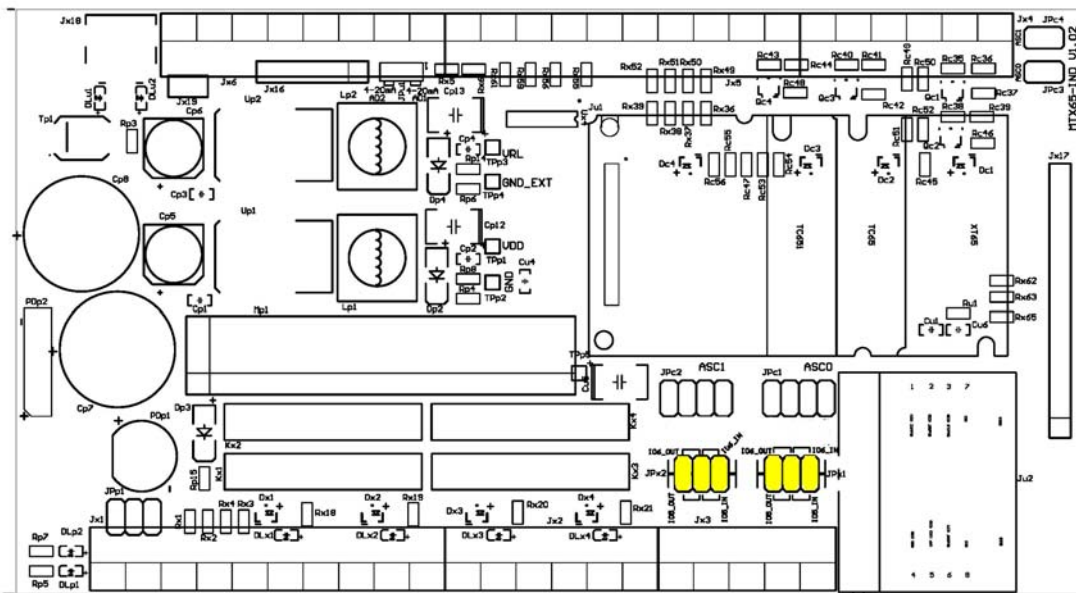

Jumper configuration

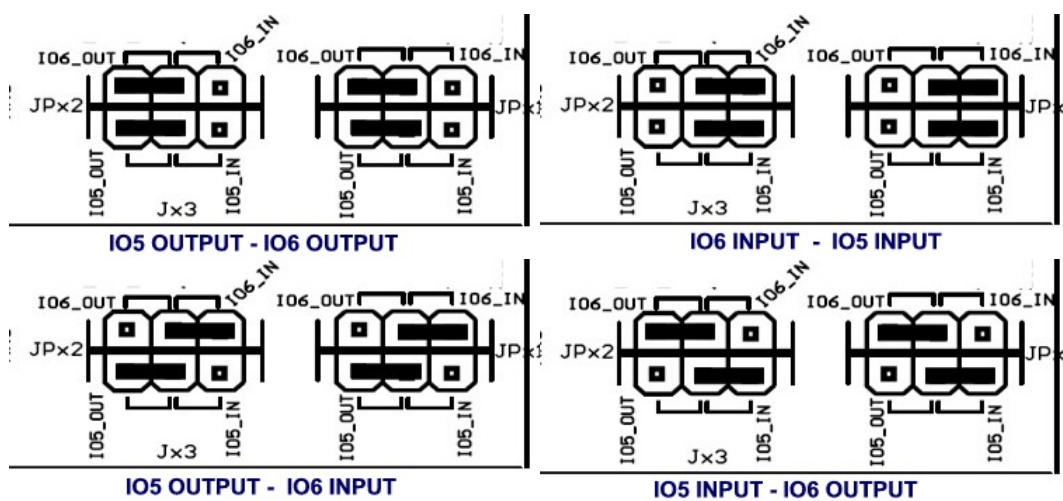

The MTX-IND Terminal provides flexible general purpose GPIO pins at the terminal block. The input/output signal direction is defined in the MTX-IND due to their internal optoisolated components. **Be sure to configure** the type of the GPIO lines either with AT commands or Java code.

The GPIO related AT commands are the following: AT^SPIO, AT^SCPIN, AT^SCPOL, AT^SCPORT, AT^SDPORT, AT^SGIO, AT^SSIO.

OPTOISOLATED INPUTS

Terminal block number	Input number	TC65i GPIO
Terminal block 38	IN10	(GPIO10 TC65i)
Terminal block 39	IN9	(GPIO9 TC65i)
Terminal block 40	IN8	(GPIO8 TC65i)
Terminal block 41	IN4	(GPIO4 TC65i)

These inputs are optoisolated.

If connected to ground GND will be a "0". If open it will be "1". We recommend that you do not apply any voltage. If necessary, do not exceed 12V.

3.7.5. Analog-to-Digital Converter (ADC)

MTX-IND has 2 Analog to Digital converters that can be configured to measure voltages and also to connect to current sensors. They can be configured with internal JUMPERS.

Terminal block number	Function
33	VEXT
34	OUT DAC
35	IN ADC2
36	IN ADC1
37	AGND

ANALOG INTERF.

Terminal block	FUNCTION		Max Values	
33	VEXT	Output voltage	3V 50mA	Direct from TC65i
34	DAC OUT	Output PWM	0-3V	Direct from TC65i
35	ADC2	Configurable 0-20mA	0-2.4	AD2 TC65i
36	ADC1	Configurable 0-20mA	0-2.4	AD1 TC65i
37	AGND			Analog ground for ADC1 & ADC2

By default, the ADC of the MTX-IND consists of 2 independent, unbalanced, multiplexed analog inputs that can be used for measuring external DC voltages in the range of 0mV...+2400mV. The ADC has a resolution of 12 bits.

It can be configured to measure currents in the range of 4-20 mA. It's intended to connect to 4-20mA type sensors.

Jumper	Terminal joined	ADC	Mode
JPu1	1-2 joined	ADC1	4-20mA (20mA = 2,4V ADC).
JPu1	3-4 joined	ADC1	4-20mA (20mA = 2,4V ADC).

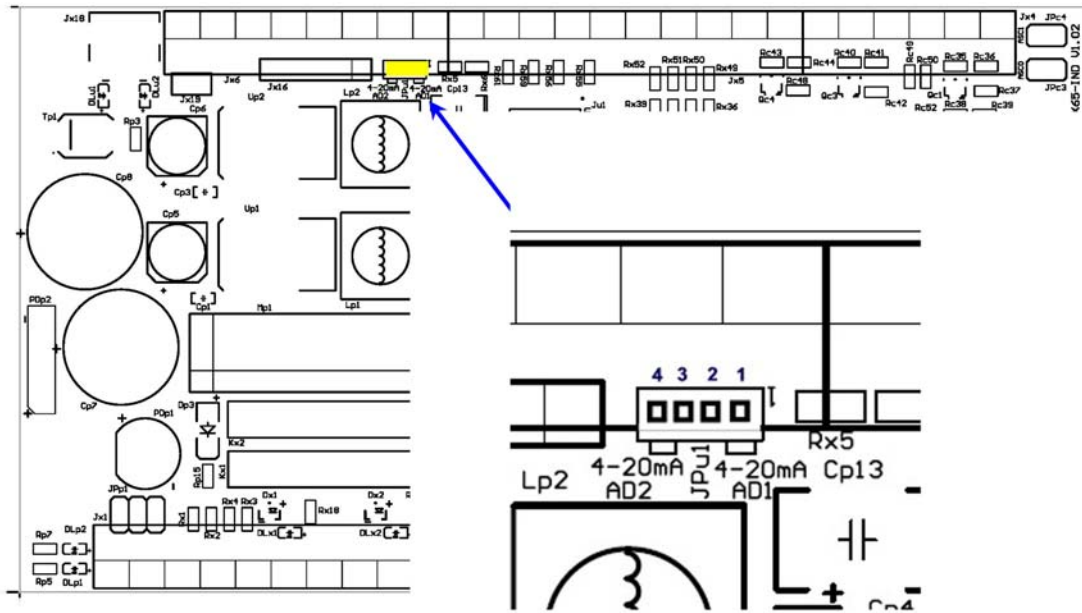

Use the command `AT^SRADC` described in [1] to select the analog inputs `ADC1_IN` or `ADC2_IN`, to set the measurement mode and to read out the measurement results. The measured values are indicated in mV.

There is no out of range detection. Voltages beyond these limits cannot be measured:

- Underflow: Values $\leq -25\text{mV}$
- Overflow: Values $> 2425\text{mV}$

The sample period is adjustable from 30s up to 100ms by `AT^SRADC`

The S&H Switch is only closed during the sample time ($t_s \sim 400\mu\text{s}$).

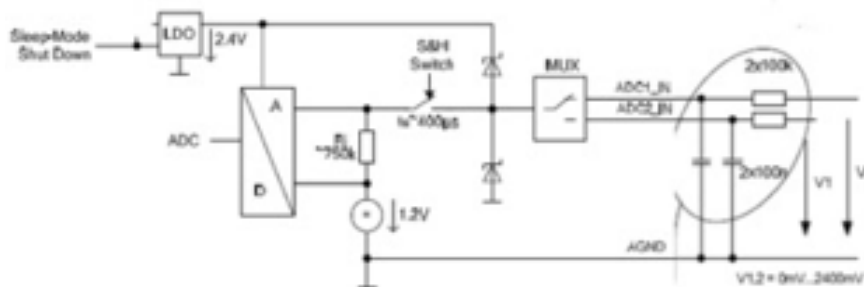

3.7.6 Real Time Clock

The TC65i module inside of the MTX-IND contains a real time clock (RTC) to maintain accurate timekeeping enables the "time stamping" of messages. This is not used, if you need the internal TC65i RTC contact gsm-support@matrix.es

3.7.7 DAC / PWM

Terminal block #34:

Digital-to-Analog Converter which can provide a PWM signal. The PWM signal can be smoothed by an external filter. Use the `AT^SWDAC` command to open and configure the `DAC_OUT` output.

DAC_OUT	O	0.2 – 3.05V
---------	---	-------------

Digital Analog Converter /
PWM signal output

3.8. Software Updates

It is possible and sometimes necessary to update the MTX-IND software. Updates must be carried out by an approved technician.

Please contact us for details Service/Programming.

4. OPERATION

4.1 Switching On the Modem

The first time power is supplied to the MTX-IND terminal (to pin 1 & pin 6 J1 power connector), it will switch on.

The modem is fully operational after 4 seconds. Logging onto a network may take longer than this and is out of the modem's control.

4.2 Switching Off the Modem

To permanently switch off the modem, connect terminal block # 3 permanently to the ground.

4.3. Automatic restart after shutdown:

This allow to the terminal to be always switched ON and be able to restart by itself. The terminal will be powered up 100% of the time if power is applied.

4.4 Operating States/LED

The modem has two LEDs, both to indicate statuses.

The POWER LED displays if power is applied and if internal power supply is working.

The SYNC LED can be operated in two different display modes: AT^SSYNC=1 or AT^SSYNC=2 (**factory default**).

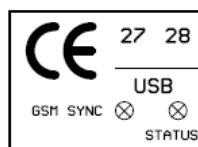

The STATUS LED is reserved for future use.

mode	LED Status
AT^SSYNC=0	<p>SYNC mode:</p> <p>Enables the SYNC pin to indicate growing power consumption during a transmit burst. You can make use of the signal generated by the SYNC pin, if power consumption is your concern. To do so, ensure that your application is capable of processing the signal. Your platform design must be such that the incoming signal causes other components to draw less current. In short, this allows your application to accommodate current drain and thus, supply sufficient current to the GSM engine if required. Note: <mode>=0 is the factory default of the TC65i module.</p>
AT^SSYNC=1	<p>LED mode:</p> <p>Enables the SYNC pin to drive a status LED installed in your application The coding of the LED is described in following section, ME status indicated by status LED patterns.</p>
AT^SSYNC=2	<p>LED mode:</p> <p>It's like <mode>=1, but additionally it enables different LED signalization in SLEEP mode depending on the status of PIN authentication and network registration. Note: <mode>=2 is the factory default of the MTX-IND Terminal.</p>

The following table is shows the different operating status and the differences in each mode.

LED behavior	ME operating status if AT^SSYNC=1	ME operating status if AT^SSYNC=2
Permanently off	ME is in one of the following modes: - POWER DOWN mode AIRPLANE mode CHARGE ONLY mode NON-CYCLIC SLEEP mode CYCLIC SLEEP mode with no temporary wake-up event in progress (1)	ME is in one of the following modes: - POWER DOWN mode AIRPLANE mode CHARGE ONLY mode
600 ms on / 600ms off	Limited Network Service: No SIM card inserted or no PIN entered, or network search in progress, or ongoing user authentication, or network login in progress	Same as for AT^SSYNC=1
75 ms on / 3 s off	IDLE mode: The mobile is registered to the GSM network (monitoring control channels and user interactions). No call is in progress.	Same as for AT^SSYNC=1
75 ms on / 75 ms off / 75 ms on / 3 s off	One or more GPRS PDP contexts activated.	Same as for AT^SSYNC=1
500 ms on / 50 ms off	Packet switched data transfer is in progress	Same as for AT^SSYNC=1
Permanently on	Depending on type of call: Voice call: Connected to remote party. Data call: Connected to remote party or exchange of parameters while setting up or disconnecting a call.	Same as for AT^SSYNC=1
<n> ms on / <n> ms off (2)	Not possible: With AT^SSYNC=1, LED signalization is disabled in SLEEP mode.	SLEEP mode is activated (AT+CFUN parameter <fun>≠ 1), but the ME is not registered to the GSM network (e.g. SIM not inserted or PIN not entered, and therefore, either no network service or only Limited Network Service is available).

1) When a temporary wake-up event (for example a call, a URC, a packet switched transfer) occurs in CYCLIC SLEEP mode the LED flashes according to the patterns listed above. See Section 2.9.1, Wake up the ME from SLEEP mode for details on the various SLEEP modes and wake-up events.

2) The duration of <n> and <m> depends on the network: In SLEEP mode, the module can only change its LED status in intermittent wake-up periods when listening to paging information from the base station. Therefore the values of <n> and <m> vary as follows:

<n> = value from 471 ms to 2118 ms

<m> = 3000 ms

5. EMBEDDED APPLICATIONS.

The MTX-IND can embed an internal application written in popular JAVA language. Java technology and several peripheral interfaces on the module allow you to easily integrate your application.

This way the customer application can be reduced because all of the resources (Microcontroller, Flash & RAM memory), all kinds of I/Os and bus peripherals can be used by the customer.

This solution saves the external intelligence with all the associated costs and also saves space and power consumption.

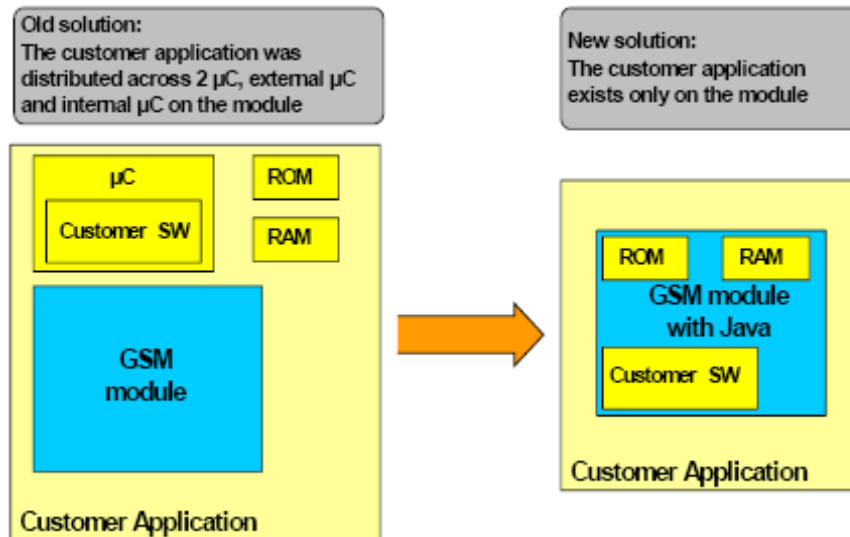

Open application resources

- ARM9© Core, Blackfin© DSP
- Memory: 400 KB (RAM) and 1.7 MB (Flash)
- Improved power-saving modes

Java™ features:

- CLDC 1.1 HI
- J2ME™ profile IMP-NG
- Secure data transmission with HTTPS, SSL and PKI

Over-the-air update

1. Application SW: OTAP
2. Firmware: FOTA (OMA compliant)

6 SAFETY AND PRODUCT CARE

Please read the information in this section and the information in "Installation of the Modem", before starting to use this product!

6.1. Safety instructions

PLEASE READ THESE SAFETY INSTRUCTIONS AND KEEP A COPY OF THEM.

- Always ensure that use of the modem is permitted. The modem may present a hazard if used in proximity to personal medical electronic devices. As a rule, the modem must not be used in hospitals, airports or planes.
- Never use the modem at a gas station, refueling point, blasting area or in any other environment where explosives may be present.
- Operating the modem close to other electronic devices, such as antennas, television sets, and radios may cause electromagnetic interference.
- This product is intended to be used with the antenna or other radiating element at least 20cm away from any part of the human body. In applications where this rule cannot be applied, the application designer is responsible for providing the SAR measurement test report and declaration.
- You are responsible for observing your country's safety standards, and where applicable, the relevant wiring rules.

6.2. General precautions

The MTX-IND Terminal as a standalone item is designed for indoor use only. For outdoor use it must be integrated into a weatherproof enclosure. Do not exceed the environmental and electrical limits as specified in "Technical Data".

- Avoid exposing the modem to lighted cigarettes, naked flames or to extreme hot or cold temperature.
- Never try to dismantle the modem yourself. There are no components inside the modem that can be serviced by the user. If you attempt to dismantle the modem, you may invalidate the warranty.
- The MTX-IND Terminal must not be installed or located where the surface temperature of the plastic case may exceed 85°C.
- All cables connected to the MTX-IND Terminal must be secured or clamped, immediately adjacent to the modem's connectors, to provide strain relief and to avoid transmitting excessive vibration to the modem in the installation
- Ensure the D.C. cable, supplying power to the MTX-IND Terminal, does not exceed 3m.
- To protect power supply cables and meet the fire safety requirements when the unit is powered from a battery or a high current supply, connect a fast 1.25A fuse in line with the positive supply.
- Do not connect any incompatible component or product to the MTX-IND Terminal.

Note! MTX-IND distributors and sales offices may refuse warranty claims where evidence of product misuse is found.

6.3. SIM card precautions

Before handling the SIM card in your application, ensure that you are not charged with static electricity. Use proper precautions to avoid electrostatic discharges.

- When the SIM card hatch is opened, the SIM card connectors lie exposed under the SIM card holder.

Caution! Do not touch these connectors! If you do, you may release an electrical discharge that could damage the modem or the SIM card.

- When designing your application, the SIM card's accessibility should be taken into account. We always recommend that you have the SIM card protected by a PIN code. This will ensure that the SIM card cannot be used by an unauthorized person.

6.4. Antenna precautions

If the antenna is to be mounted outside, consider the risk of lightning. Follow the instructions provided by the antenna manufacturer.

- Never connect more than one modem to a single antenna. The modem can be damaged by radio frequency energy from the transmitter of another modem.
- Like any mobile station, the antenna of the modem emits radio frequency energy. To avoid EMI (electromagnetic interference), you must determine whether the application itself, or equipment in the application's proximity, needs further protection against radio emission and the disturbances it might cause. Protection is secured either by shielding the surrounding electronics or by moving the antenna away from the electronics and the external signals cable.
- The modem and antenna may be damaged if either come into contact with ground potentials other than the one in your application. Beware, ground potential are not always what they appear to be.

6.5. Radio Frequency (RF) exposure and SAR

Your wireless modem device is a low-power radio transmitter and receiver (transceiver). When it is turned on, it emits low levels of radio frequency energy (also known as radio waves or radio frequency fields).

Governments around the world have adopted comprehensive international safety guidelines, developed by scientific organizations, e.g. ICNIRP (International Commission on Non-Ionizing Radiation Protection) and IEEE (The Institute of Electrical and Electronics Engineers Inc.), through periodic and thorough evaluation of scientific studies. These guidelines establish permitted levels of radio wave exposure for the general population. The levels include a safety margin designed to assure the safety of all persons, regardless of age and health, and to account for any variations in measurements.

Specific Absorption Rate (SAR) is the unit of measurement for the amount of radio frequency energy absorbed by the body when using a transceiver. The SAR value is determined at the highest certified power level in laboratory conditions, but the actual SAR level of the transceiver while operating can be well below this value. This is because the transceiver is designed to use the minimum power required to reach the network.

The MTX-IND wireless modem device has been approved for applications where the antenna is located >20cm from the body. In all other configurations the user is responsible for meeting the local SAR regulations.

Users of the MTX-IND wireless modem device are responsible for ensuring that they meet the SAR regulatory requirements of the countries in which they intend to operate the device, and that their documentation contains the relevant SAR declaration, certification information, and user guidance as appropriate.

6.6. Personal Medical Devices

Wireless modem devices may affect the operation of cardiac pacemakers, hearing aids and certain other implanted equipment. If a minimum distance of 15 cm (6 inches) is maintained between the MTX-IND terminal radiating antenna and a pacemaker, the risk of interference is limited. If the user's application is likely to be situated in the vicinity of personnel, a suitable warning should be contained in the equipment manual to this effect.

7. INSTALLATION OF THE MODEM

This chapter gives you advice and helpful hints on how to integrate the MTX-IND Terminal into your application from a hardware perspective.

7.1 Where to install the modem

There are several conditions which need to be taken into consideration when designing your application as they might affect the modem and its function. They are:

7.1.1 Environmental conditions

The modem must be installed so that the environmental conditions stated in the Technical Data chapter, such as temperature, humidity and vibration are satisfied.

Additionally, the electrical specifications in the Technical Data section must not be exceeded.

7.1.2 Signal strength

The modem has to be placed in a way that ensures sufficient signal strength. To improve signal strength, the antenna can be moved to another position. Signal strength may depend on how close the modem is to a radio base station. You must ensure that the location, at which you intend to use the modem, is within the network coverage area. Degradation in signal strength can be the result of a disturbance from another source, for example an electronic device in the immediate vicinity. More information about possible communication disturbances can be found in section 7.3.5.

When an application is completed, you can verify signal strength by issuing the AT command AT+CSQ. See "AT+CSQ Signal Strength".

Tip! Before installing the modem, use an ordinary mobile telephone to check a possible location for it. In determining the location for the modem and antenna, you should consider signal strength as well as cable length.

7.1.3 Connections of components to MTX-IND Terminal

The user is responsible for the final integrated system. Incorrectly designed or installed, external components may cause radiation limits to be exceeded. For instance, improperly made connections or improperly installed antennas can disturb the network and lead to malfunctions in the modem or equipment.

7.1.4 Network and Subscription

Before your application is used, you must ensure that your chosen network provides the necessary telecommunication services. Contact your service provider to obtain the necessary information.

- If you intend to use SMS in the application, ensure this is included in your (voice) subscription.
- Consider the choice of the supplementary services.

7.2 How to install the modem

7.2.1 Power supply

- Use a high-quality power supply cable with low resistance. This ensures that the voltages at the connector pins are within the allowed range, even during the maximum peak current.
- When the unit is powered from a battery or a high current supply, connect a 1.25A fuse in line with the positive supply. This protects the power cabling and modem.

7.2.2 Securing the modem

Before securing the modem take into account the amount of additional space required for the mating connectors and cables that will be used in the application.

- Where access is restricted, it may be easier to connect all the cables to the modem prior to securing it in the application.

7.3 Antenna

7.3.1 General

The antenna is the component in your system that maintains the radio link between the network and the modem. Since the antenna transmits and receives electromagnetic energy, its efficient function will depend on:

- The type of antenna (for example, circular or directional);
- The placement of the antenna;
- Communication disturbances in the vicinity in which the antenna operates.

In the sections below, issues concerning antenna type, antenna placement, antenna cable and possible communication disturbances are addressed. In any event, you should contact your local antenna manufacturer for additional information concerning antenna type, cables, connectors, antenna placement and the surrounding area.

You should also determine whether the antenna needs to be grounded or not. Your local antenna manufacturer might be able to design a special antenna suitable for your application.

7.3.2 Antenna type

Make sure that you choose the right type of antenna for the modem. Consider the following requirements:

- The antenna must be designed for the one of the frequency bands in use; please ask your network provider for more information:
 - GSM 850/900 MHz
 - GSM 1800/1900 MHz;
- The impedance of the antenna and antenna cable must be 50Ω;
- The antenna output-power handling must be a minimum of 2W;
- The VSWR value should be less than 3:1 to avoid damage to the modem.

7.3.3 Antenna placement

The antenna should be placed away from electronic devices or other antennas. The recommended minimum distance between adjacent antennas, operating in a similar radio frequency band, is at least 50cm. If signal strength is weak, it is useful to face a directional antenna at the closest radio base station. This can increase the strength of the signal received by the modem. The modem's peak output power can reach 2W.

RF field strength varies with antenna type and distance. At 10cm from the antenna the field strength may be up to 70V/m and at 1m it will have reduced to 7V/m. In general, CE-marked products are for residential/commercial areas and light industry as they can withstand a minimum of 3V/m.

7.3.4 The antenna cable

Use 50Ω impedance low-loss cable and high-quality 50Ω impedance connectors (frequency range up to 2GHz) to avoid RF losses. Ensure that the antenna cable is as short as possible. The Voltage Standing-Wave Ratio (VSWR) may depend on the effectiveness of the antenna, cable and connectors. In addition, if you use an adapter between the antenna cable and the antenna connector, it is crucial that the antenna cable is a high-quality, low-loss cable. Minimize the use of extension cables, connectors and adapters. Each additional cable, connector or adapter causes a loss of signal power.

7.3.5 Possible communications disturbances

Possible communication disturbances include the following:

- **Noise** can be caused by electronic devices and radio transmitters.
- **Path-loss** occurs as the strength of the received signal steadily decreases in proportion to the distance from the transmitter.
- **Shadowing** is a form of environmental attenuation of radio signals caused by hills, buildings, trees or even vehicles. This can be a particular problem inside buildings, especially if the walls are thick and reinforced.
- **Multi-path fading** is a sudden decrease or increase in the signal strength. This is the result of interference caused when direct and reflected signals reach the antenna simultaneously. Surfaces such as buildings, streets, vehicles, etc., can reflect signals.
- **Hand-over** occurs as you move from one cell to another in the GSM network. Your mobile application call is transferred from one cell to the next. Hand-over can briefly interfere with communication and may cause a delay or at worst, a disruption.

8. ACCESSORIES

The MTX-IND has been type approved together with a range of accessories including: Power supply, all type of antennas (indoor, outdoor, high gain, etc...), cables and a DIN adapter

The following is an example of this; please visit www.matrix.es/MTX-Terminals to see the full-range of accessories.

8.1. POWER SUPPLY

8.1.1 AC Power Adaptor



SP-12AS
 Power supply rail DIN
 Output: 12V 3A
 Compact design, small size and light weight
 High efficiency and good reliability
 Internal EMI filter
 Power Output LED Indicator
 Remote Control Function
 Over-heat Protection
 Short-circuit protection and over-load protection
 UPS Function
 Certificate : CE Certificate

Dimensions(L×W×H)	71mm×106mm×65mm
Installation	Standard 35mm DIN (EN50022-35)
Full-range Voltage Input	100-240VAC/140-340VDC
Waving Voltage Allowance Range	85-264VAC/120-370VDC
Input Frequency	47-63Hz
Output Voltage Stability	≤±0.5%
Ripple	≤150mVp-p
Temperature	-25°C~+70°C
Insulation and Breakdown	>1.5KV
Efficiency	>75%

8.1.2 DC cable

2.5m Fused DC Power Cable for GSM terminals
 Fuse: 0.5A



ORDERING CODE: 118.003.330

8.2. ANTENNAS

8.2.1 Magnetic Dual Band Antenna (900/1800MHz)

OPANIEL TECHNOLOGIES <http://www.opaniel.com>

Model: MTX-FME F (whips 6 & 22 cm)

Magnetic-mount antenna, 3m RG174 cable with FME female connector

0dB radiator for whip 6 cm.

3dB radiator for whip 22 cm.

Ordering code: 118.009.000



8.2.2 Right angle short antenna



OPANIEL TECHNOLOGIES <http://www.opaniel.com>

Model: MTX-ACODADA FME F

L= 5 + 2.5 cm

Gain= 0dB

ORDERING CODE: 118.007.004

8.2.3 Patch Adhesive Antenna

OPANIEL TECHNOLOGIES <http://www.opaniel.com>

Model: MTX-UT902 – FME F

MTX- UT-902, RG174 3 metres

GSM DUAL BAND (900 / 1800 MHz) ANTENNA

Patch Antenna

Cable RG174 3 metres

Gain 2 dB

Frequency: 824-960 MHz, 1770-1880 MHz



ORDERING CODE: 118.007.003

To see a larger range of antenna products, please go to the following website:

<http://www.opaniel.com/products/default.asp?IDP=2>

8.3. CABLES

8.3.2 USB CABLE

USB-A to Mini USB-B 1.5m length cable.

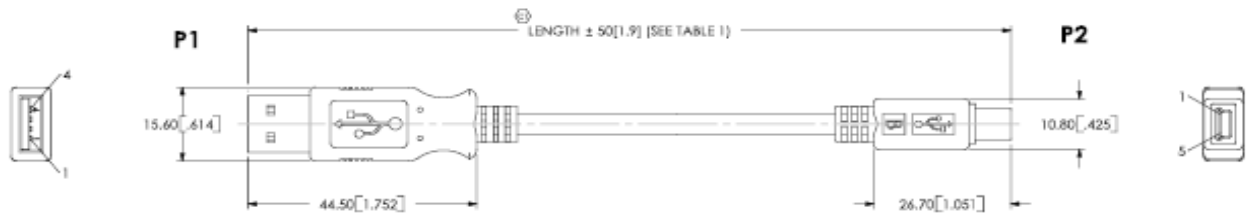

Ordering Code: 120.003.222

8.4. DEVELOPMENT KITS

SOFTWARE and Documentation for MTX-IND. (Module TC65i inside)

Ask gsm-support@matrix.es for FTP user & password details

9. CONFORMITY ASSESSMENT

MATRIX ELECTRONICA S.L.
Alejandro Sanchez 109
28019 Madrid
Spain

We declare under our sole responsibility that the products, MTX-IND Terminal V1.0 containing Cellular Engine Cinterion WM engine TC65i, to which this declaration relates are in conformity with the following standards and/or directives:

DIRECTIVES

EC Directive of the European Parliament and of the council of 9 March 1999 on radio equipment and telecommunications terminal equipment and the mutual recognition of their conformity (in short referred to as R&TTE Directive 1999/5/EC).

The product is labeled with the CE conformity mark 89/336/EC Directive on electromagnetic compatibility 73/23/EC Directive on electrical equipment designed for use within certain voltage limits (Low Voltage Directive)

Directive 2002/95/EC of the European Parliament and of the Council of 27 January 2003 on the restriction of the use of certain hazardous substances in electrical and electronic equipment (RoHS)

STANDARDS of EUROPEAN TYPE APPROVAL

3GPP TS 51.010-1: Digital cellular telecommunications system (Phase 2); Mobile Station (MS) conformance specification

ETSI EN 301 511 V9.0.2: Global System for Mobile communications (GSM); Harmonized standard for mobile stations in the GSM 900 and DCS 1800 bands covering essential requirements under article 3.2 of the R&TTE directive (1999/5/EC) (GSM 13.11 version 7.0.1 Release 1998)

ETSI EN 301 489-1 V1.4.1: Electro Magnetic Compatibility and Radio spectrum Matters (ERM); Electro Magnetic Compatibility (EMC) standard for radio equipment and services; Part 1: Common Technical Requirements

ETSI EN 301 489-7 V1.2.1: Candidate Harmonized European Standard (Telecommunications series) Electro Magnetic Compatibility and Radio spectrum Matters (ERM); Electro Magnetic Compatibility (EMC) standard for radio equipment and services; Part 7: Specific conditions for mobile and portable radio and ancillary equipment of digital cellular radio telecommunications systems (GSM and DCS)

IEC/EN 60950-1 (2001): Safety of information technology equipment (2000)

The technical documentation relevant to the above equipment will be held at
MATRIX ELECTRONICA S.L.
Alejandro Sanchez 109
28019 Madrid
Spain

Madrid, 24th September 2007.
Mr. J. Vicente
Managing Board

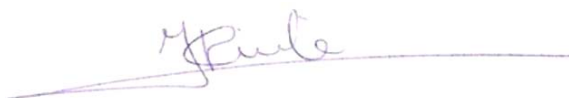

FCC COMPLIANT AND SAR INFORMATION

MTX-IND complaints with FCC regulations.

Equipment class: PCS Licensed Transmitter
Notes: Quad band GSM/GPRS Modem

MTX-IND Contains FCC ID: QIPTC65

Cinterion Wireless Modules models: TC63, TC65, TC63i and TC65i are marketed without defined antenna.

Maximum Gain antenna using indoor antennas depends on distance from antenna to any nearby persons in normal operation should not exceed values shown in below table.

According to the limit in 47 CFR 1.1310, we get the value of the maximum antenna gain as follows:

The maximum measured power output in the 850 MHz band is 1866.38 mW (32.71 dBm, see 7layers test report MDE_Siem_0714_FCCb).

The maximum permissible exposure is defined in 47 CFR 1.1310 with 0.55773 mW/cm².

The maximum measured power output in the 1900 MHz band is 974.99 mW (29.89 dBm, see 7layers test report MDE_Siem_0714_FCCc).

The maximum permissible exposure is defined in 47 CFR 1.1310 with 1 mW/cm².

According to the limit in 47 CFR 1.1310, we get the value of the maximum antenna gain as follows:

$$S = P \cdot G / 4\pi R^2$$

$$S = 0.55773 \text{ mW/cm}^2 \text{ or } 1 \text{ mW/cm}^2$$

$$P = 1866.38 \text{ mW or } 974.99 \text{ mW}$$

$$R = 20 \text{ cm or } 100\text{cm}$$

$$\pi = 3.1416$$

$$G(\text{dBi}) = 10 \cdot \log_{10}(G)$$

Solving for G; the maximum antenna gain is

Band	Distance	Maximum Gain in dBi
850MHz	20cm	1.7669
850MHz	50cm	9.7257
1900MHz	20cm	7.1227
1900MHz	50cm	15.0815

10. ROHS STATEMENT

The MTX-IND is compliant with the 2002/95/EC Directive of the European Parliament and of the Council of 27 January 2003 on the restriction of the use of certain hazardous substances in electrical and electronic equipment (RoHS).



We follow RoHS criteria to have PBDE (including deca-BDE) to be under 1000ppm (0.1%).

11. DISPOSAL OF OLD ELECTRICAL & ELECTRONIC EQUIPMENT (WEEE MARK)



This symbol, applied on our products and/or on its packaging, indicates that this product should not be treated as household waste when you wish to dispose of it. Instead, it should be handed over to an applicable collection point for the recycling of electrical and electronic equipment. By ensuring this product is disposed of correctly, you will help prevent potential negative consequences to the environment and human health, which could otherwise be caused by inappropriate disposal of this product. The recycling of materials will help to conserve natural resources. For more detailed information about the recycling of this product, please contact your local city office, household waste disposal service or the retail store where you purchased this product.

12. ABBREVIATIONS

Abbreviation	Explanations
CBM	Cell Broadcast Message
CBS	Cell Broadcast Service
CSD	Circuit Switched Data
DCE	Data Circuit Terminating Equipment
DTE	Data Terminal Equipment
DTMF	Dual Tone Multi Frequency
EFR	Enhanced Full Rate
EMC	Electro-Magnetic Compatibility
ETSI	European Telecommunication Standards Institute
FR	Full Rate
GPRS	General Packet Radio Service
GSM	Global System for Mobile Communication
HR	Half Rate
HSCSD	High Speed Circuit Switched Data
ITU-T	International Telecommunication Union - Telecommunications Standardization Sector
ME	Mobile Equipment
MO	Mobile Originated
MS	Mobile Station
MT	Mobile Terminated
PDU	Protocol Data Unit
RLP	Radio Link Protocol
RF	Radio Frequency
RTC	Real Time Clock
SIM	Subscriber Identity Module
SMS	Short Message Service
TA	Terminal Adapter
TE	Terminal Equipment
TS	Telecom Services

13. AT COMMAND SUMMARY

The AT standard is a line-oriented command language. AT is an abbreviation of ATtention and it is always used to start sending a command line from the terminal equipment (TE) to the terminal adaptor (TA). The command line consists of a string of alphanumeric characters. It is sent to the MTX-IND to instruct it to perform the commands specified by the characters.

The AT commands listed below are supported by the within the MTX-IND. The AT command user manual can be downloaded from the MTX-IND web page: www.matrix.es/MTX-TERMINALS.

AT Command	Description
+++	Switch from data mode to command mode
^SSTN	SAT Notification
A/	Repeat previous command line
AT&C	Set Data Carrier Detect (DCD) Line mode
AT&D	Set circuit Data Terminal Ready (DTR) function mode
AT&F	Set all current parameters to manufacturer defaults
AT&S	Set circuit Data Set Ready (DSR) function mode
AT&V	Display current configuration
AT&W	Stores current configuration to user defined profile
AT+CACM	Accumulated call meter (ACM) reset or query
AT+CALA	Set alarm time
AT+CAMM	Accumulated call meter maximum (ACMmax) set or query
AT+CAOC	Advice of Charge information
AT+CBST	Select bearer service type
AT+CCFC	Call forwarding number and conditions control
AT+CCLK	Real Time Clock
AT+CCUG	Closed User Group
AT+CCWA	Call Waiting
AT+CEER	Extended Error Report
AT+CFUN	Set phone functionality
AT+CGACT	PDP context activate or deactivate
AT+CGANS	Manual response to a network request for PDP context activation
AT+CGATT	GPRS attach or detach
AT+CGAUTO	Automatic response to a network request for PDP context activation
AT+CGDATA	Enter data state
AT+CGDCONT	Define PDP Context
AT+CGEQMIN	3G Quality of Service Profile (Minimum acceptable)
AT+CGEQREQ	3G Quality of Service Profile (Requested)
AT+CGMI	Request manufacturer identification
AT+CGMM	Request model identification

AT+CGMR	Request revision identification of software status
AT+CGPADDR	Show PDP address
AT+CGQMIN	Quality of Service Profile (Minimum acceptable)
AT+CGQREQ	Quality of Service Profile (Requested)
AT+CGREG	GPRS Network Registration Status
AT+CGSMS	Select service for MO SMS messages
AT+CGSN	Request International Mobile Equipment Identity (IMEI)
AT+CHLD	Call Hold and Multiparty
AT+CHUP	Hang up call
AT+CIMI	Request International Mobile Subscriber Identity (IMSI)
AT+CIND	Indicator control
AT+CLCC	List current calls of ME
AT+CLCK	Facility lock
AT+CLIP	Calling Line Identification Presentation
AT+CLIR	Calling line identification restriction
AT+CLVL	Loudspeaker volume level
AT+CMEE	Mobile Equipment Error Message Format
AT+CMER	Mobile Equipment Event Reporting
AT+CMGC	Send an SMS command
AT+CMGD	Delete short message
AT+CMGF	Select SMS message format
AT+CMGL	List SMS messages from preferred store
AT+CMGR	Read SMS messages
AT+CMGS	Send Short Message
AT+CMGW	Write Short Messages to Memory
AT+CMSS	Send short messages from storage
AT+CMUT	Mute control
AT+CMUX	Enter multiplex mode
AT+CNMA	New Message Acknowledgement to ME/TE, only phase 2+
AT+CNMI	New short Message Indication
AT+CNUM	Read own numbers
AT+COLP	Connected Line Identification Presentation
AT+COPN	Read operator names
AT+COPS	Operator Selection
AT+CPAS	Mobile equipment activity status
AT+CPBR	Read from Phonebook
AT+CPBS	Select phonebook memory storage
AT+CPBW	Write into Phonebook
AT+CPIN	PIN Authentication

AT+CPIN2	PIN2 Authentication
AT+CPMS	Preferred SMS message storage
AT+CPOL	Preferred Operator List
AT+CPUC	Price per unit and currency table
AT+CPWD	Change Password
AT+CR	Service reporting control
AT+CRC	Set Cellular Result Codes for incoming call indication
AT+CREG	Network registration
AT+CRLP	Select radio link protocol parameters for originated non-transparent data calls
AT+CRSM	Restricted SIM Access
AT+CSCA	SMS Service Center Address
AT+CSCB	Select Cell Broadcast Message Indication
AT+CSCS	Select TE character set
AT+CSDH	Show SMS text mode parameters
AT+CSMP	Set SMS text Mode Parameters
AT+CSMS	Select Message Service
AT+CSNS	Single Numbering Scheme
AT+CSQ	Signal quality
AT+CSSN	Supplementary service notifications
AT+CUSD	Supplementary service notifications
AT+CXXCID	Display card ID
AT+FCLASS	Fax: Select, read or test service class
AT+FRH	Receive Data Using HDLC Framing
AT+FRM	Receive Data
AT+FRS	Receive Silence
AT+FTH	Transmit Data Using HDLC Framing
AT+FTM	Transmit Data
AT+FTS	Stop Transmission and Wait
AT+GCAP	Request complete TA capabilities list
AT+GMI	Request manufacturer identification
AT+GMM	Request model identification
AT+GMR	Request revision identification of software status
AT+GSN	Request International Mobile Equipment Identity (IMEI)
AT+ICF	Serial Interface Character Framing
AT+IFC	Set Flow Control separately for data directions
AT+ILRR	Set TE-TA local rate reporting
AT+IPR	Set fixed local rate
AT+VTD	Tone duration
AT+VTS	DTMF and tone generation

AT+WS46	Select wireless network
AT\Q	Flow control
AT\V	Set CONNECT result code format
AT^MONI	Monitor idle mode and dedicated mode
AT^MONP	Monitor neighbour cells
AT^SAADC	Show ADC Adjustment Values
AT^SACM	Advice of charge and query of ACM and ACMmax
AT^SAIC	Audio Interface Configuration
AT^SALS	Alternate Line Service
AT^SBC	Battery Charge Control
AT^SBV	Battery/Supply Voltage
AT^SCCNT	Configure Pulse Counter
AT^SCFG	Extended Configuration Settings
AT^SCID	Display SIM card identification number
AT^SCKS	Query SIM and Chip Card Holder Status
AT^SCML	List Concatenated Short Messages from preferred store
AT^SCMR	Read Concatenated Short Messages
AT^SCMS	Send Concatenated Short Messages
AT^SCMW	Write Concatenated Short Messages to Memory
AT^SCNI	List Call Number Information
AT^SCPIN	Pin Configuration
AT^SCPOL	Polling Configuration
AT^SCPORT	Port Configuration
AT^SCSL	Customer SIM Lock
AT^SCTM	Set critical operating temperature presentation mode or query temperature
AT^SDLD	Delete the 'last number redial' memory
AT^SDPORT	Delete a Port Configuration
AT^SFDL	Enter Firmware Download Mode
AT^SFNUR	Select the fixed network user rate
AT^SGACT	Query all PDP context activations
AT^SGAUTH	Set type of authentication for PPP connection
AT^SGCONF	Configuration of GPRS related Parameters
AT^SGIO	Get IO state of a specified pin or port
AT^SHOM	Display Homezone
AT^SHUP	Hang up call(s) indicating a specific GSM04.08 release cause
AT^SICC	Internet Connection Close
AT^SICI	Internet Connection Information
AT^SICO	Internet Connection Open
AT^SICS	Internet Connection Setup Profile

AT^SIND	Extended Indicator Control
AT^SISC	Internet Service Close
AT^SISE	Internet Service Error Report
AT^SISI	Internet Service Information
AT^SISO	Internet Service Open
AT^SISR	Internet Service Read Data
AT^SISS	Internet Service Setup Profile
AT^SISW	Internet Service Write Data
AT^SISX	Internet Service Execution
AT^SJNET	Set Dialup Network Access Parameters
AT^SJOTAP	Over The Air Application Provisioning
AT^SJRA	Run Java Application
AT^SJSEC	Write Binary Java Security Data
AT^SLCC	Cinterion defined command to list current calls of ME
AT^SLCD	Display Last Call Duration
AT^SLCK	Facility lock
AT^SLMS	List SMS Memory Storage
AT^SM20	Set M20 compatibility mode
AT^SMGL	List Short Messages from preferred store without setting status to REC READ
AT^SMGO	Set or query SMS overflow presentation mode or query SMS overflow
AT^SMGR	Read short message without setting status to REC READ
AT^SMONC	Cell Monitoring
AT^SMOND	Cell Monitoring
AT^SMONG	GPRS Monitor
AT^SMSO	Switch off mobile station
AT^SNFA	Set or query of microphone attenuation
AT^SNFD	Set audio parameters to manufacturer default values
AT^SNFI	Set microphone path parameters
AT^SNFM	Set microphone audio path and power supply
AT^SNFO	Set audio output (= loudspeaker path) parameter
AT^SNFPT	Set progress tones
AT^SNFS	Select audio hardware set
AT^SNFTTY	Signal TTY/CTM audio mode capability
AT^SNFV	Set loudspeaker volume
AT^SNFW	Write audio setting in non-volatile store
AT^SOPS	Extended Operator Selection
AT^SPBC	Find first matching entry in sorted phonebook
AT^SPBD	Purge phonebook memory storage

AT^SPBG	Display phonebook entries in alphabetical order
AT^SPBS	Step through the selected phonebook alphabetically
AT^SPIC	Display PIN counter
AT^SPIO	General Purpose IO Driver Open/Close
AT^SPLM	Read the PLMN list
AT^SPLR	Read entry from the preferred operators list
AT^SPLW	Write an entry to the preferred operators list
AT^SPWD	Change Password
AT^SRADC	Configure and Read ADC Measurement
AT^SRSA	Remote SIM Access Activation
AT^SRSM	Remote SIM Access Message
AT^SRTC	Ring tone configuration
AT^SSCNT	Start and Stop Pulse Counter
AT^SSCONF	SMS Command Configuration
AT^SSDA	Set SMS Display Availability
AT^SSET	Indicate SIM data ready
AT^SSIO	Set IO state of a specified pin or port
AT^SSMSS	Set Short Message Storage Sequence
AT^SSPI	Serial Protocol Interface
AT^SSTA	SAT Interface Activation
AT^SSTGI	SAT Get Information
AT^SSTR	SAT Response
AT^SSYNC	Configure SYNC Pin
AT^STCD	Display Total Call Duration
AT^STPB	Transmit Parity Bit (for 7E1 and 7O1 only)
AT^SWDAC	Configure and Read PWM Signal for DAC
AT^SXSM	Extended SIM Access
ATA	Answer a call
ATA	Manual response to a network request for PDP context activation
ATD	Mobile originated call to specified number
ATD*98#	Request GPRS IP service
ATD*99#	Request GPRS service
ATD><mem><n>	Mobile originated call using specific memory and index number
ATD><n>	Mobile originated call from active memory using index number
ATD><str>	Mobile originated call from active memory using corresponding field -
ATDI	Mobile originated call to ISDN number
ATDL	Redial last number used
ATE	Enable command echo
ATH	Disconnect existing connection

ATH	Manual rejection of a network request for PDP context activation
ATI	Display product identification information
ATL	Set monitor speaker loudness
ATM	Set monitor speaker mode
ATO	Switch from command mode to data mode / PPP online mode
ATP	Select pulse dialing
ATQ	Set result code presentation mode
ATS0	Set number of rings before automatically answering a call
ATS0	Automatic response to a network request for PDP context activation
ATS10	Set disconnect delay after indicating the absence of data carrier
ATS18	Extended call release report
ATS3	Set command line termination character
ATS4	Set response formatting character
ATS5	Write command line editing character
ATS6	Set pause before blind dialing
ATS7	Set number of seconds to wait for connection completion
ATS8	Set number of seconds to wait for comma dialing modifier
ATT	Select tone dialing
ATV	Set result code format mode
ATX	Set CONNECT result code format and call monitoring
ATZ	Set all current parameters to user defined profile

