

SIGNALFIRE

wireless telemetry

SignalFire Remote Sensing System™

Scott Keller
CEO, SignalFire Telemetry Inc.
Scott.Keller@signal-fire.com

Al Hamilton
President, SignalFire Telemetry Inc.
Al.Hamilton@signal-fire.com

The SignalFire Remote Sensing System™ (SFRSS™) is a sensor independent wireless mesh networking system that has been designed for challenging outdoor environments where individual assets may be a mile or more apart. This document describes the major components and how they function in the network.

The system consists of remote nodes that monitor and control assets and a gateway which provides access to and from the remote nodes via the SignalFire Telemetry System.

Remote Nodes

The function of a remote node is to connect to a device and extract data from that device or send control data to that device. It communicates with the gateway through the SignalFire Network. There are 2 broad classes of remote nodes in the SFRSS, analog nodes and digital nodes.

Analog Sensor Nodes



SFRSS A2 Powering and Monitoring a 4-20 mA Pressure Sensor on an injection well

An analog node connects to an analog sensor such as a pressure, vacuum, humidity, range, temperature or other sensor that has an analog output. Typical sensor interfaces include Hart™, 1-5 V, 4-20 mA. The SignalFire SFRSS A2 or SFRSS HART nodes are designed to connect to these types of sensors.

The SFRSS A2 or SFRSS Hart may be either line powered or battery powered. The intrinsically safe Multi Input system is only battery powered. When line powered, it will participate as a fulltime component of the SignalFire Mesh Network. It will forward messages to and from the Gateway from other nodes. The intrinsically safe Multi Input system is only battery powered and has Hart, 1-5V, 4-20 mA, and Digital Input interfaces.

When configured for battery powered operation, SignalFire Analog Sensor Nodes provide the ability for truly autonomous sensor operation. Not only does the battery power the RF communications but it also powers the sensor - eliminating the need to

run separate power lines.



SFRSS HART Node Connected to a pressure sensor for tank level monitoring

The user configures the node for a check-in interval (1 min to 2 hours). The node spends most of its time “sleeping” in low power mode. It wakes up at the check-in interval, powers the sensor (typically at 15 VDC), permits the sensor to stabilize, takes a reading, turns the sensor off, turns the SignalFire radio on, transmits data and goes back to sleep. This unique capability makes it feasible to operate 4-20 mA current loop sensors without the expense of running conduit for power to the sensor.

In order to assure extended operation over a wide temperature range, battery powered versions of the SignalFire Analog Sensor Nodes use high capacity Lithium primary batteries. The use of alkaline batteries is not recommended as the internal resistance in an alkaline battery may cause unacceptable voltage drops during the sensor power cycle at temperatures below as high as 5 C. Battery life can be measured in years depending on the demands of the sensor which typically dominate the power consumption of the system.



SFRSS A1 Short Range Single Channel Analog System

A lower cost version, the SFRSS A1, is designed for shorter range communications (approx ¼ mile) and has a single analog input that accepts either 4-20 mA or 1-5 V inputs.

Digital Sensor Nodes



SignalFire Modbus-in-a-Stick connected to an irrigation flow sensor

Digital Sensor Nodes connect to devices that contain a digital interface rather than an analog one. The most common digital interface is Modbus. Modbus is a multi node, RS 485 serial bus interface that uses registers to store sensor data and commands. The SFRSS Modbus-in-a-Stick nodes connect to Modbus Sensors using the standard RS 485 connection.

Digital Sensors typically operate full time and the SignalFire Digital Sensor nodes are typically always-on as well. This permits them to form a full time mesh backbone for a mixed network of battery powered analog nodes, and powered analog or digital nodes.

SFRSS Modbus-in-a-Stick nodes read user-defined register values on a regular schedule (set with a rotary switch in the unit) and send the data to the gateway. They can also write registers based on data sent from the gateway. This allows remote parameter modification and/or remote control (relay control, for example).

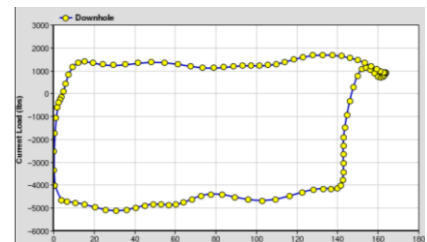

Pump Data Card transmitted by a SignalFire Modbus-in-a-stick (Image courtesy of Wellkeeper, Inc.)

Modbus-in-a-Stick units can also be optionally configured to download larger, non register based files such as flow meter custody files.

SignalFire offers 2 units designed to do digital IO. The Counter-in-a-Stick can be configured to various digital inputs such as contact closure or open drain and can also be configured with an optional relay board to control local devices. The SFRSS D2 offers a low cost digital input.

Weigand is a popular card reader interface for access control. SignalFire has that base covered as well with its Weigand-in-a-Stick product.

Gateway

The purpose of the gateway is to provide an interface between the remote mesh network and the outside world. SignalFire’s Remote Sensing System utilizes the industry-standard Modbus interface. In the Gateway, each remote

sensor has had a unique Modbus slave ID. Data from the remote nodes is stored in local gateway registers using the slave ID of the remote sensor.

The Gateway requires minimal set up. Each node installs itself and its associated registers on the Gateway automatically.



SignalFire Gateway In a Stick™ Integrated antenna and Gateway



SignalFire Gateway-in-a-Stick connected to an RTU at a tank battery

The Gateway stores the most recent data sent in from a node in its register memory. It connects to the control unit via a standard RS 485 serial line that may also be attached to other Modbus devices. When the gateway recognizes a poll for a device registered in its memory it will respond. Data stored in the gateway is timed out if a node does not report in for several reporting cycles. This alerts the user to nodes that might be off-line.

The system can also send data to a remote digital node. When the gateway receives a command to write a modbus register or to a device under its command, it will use the SignalFire mesh network to send the write command to the appropriate node and respond back with a write confirmation.

The SignalFire Telemetry System

SFRSS is built on the foundation of the SignalFire Mesh Networking Technology. This technology permits each node to self-install, determine its communications environment, and automatically adapt to changes in that environment. For example, the nodes adapt to changes in traffic volumes, radio conditions, gateway availability, presence or absence of neighbors, and power-source conditions.

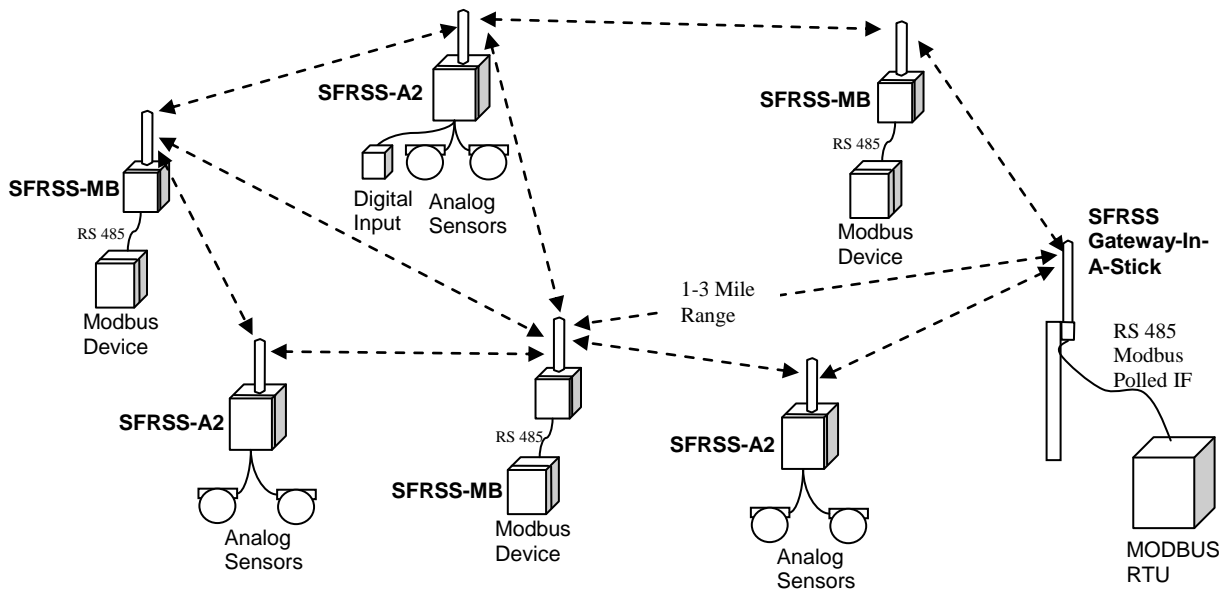

The SignalFire Message Forwarding System

Sensor Independence

SFRSS is designed to work with industry standard sensors interfaces. This means that it is possible to retrofit existing applications and reuse existing sensors. There is no requirement to use sensors from a particular vendor to have a full wireless network. All the data is presented at the gateway in an industry standard Modbus format.

Summary

The SignalFire Remote Sensing System permits robust communications with devices of the customer's choice in difficult outdoor environments. If you have a tough application give us a call, we love a challenge!

SignalFire Telemetry System Node Types

Node	Description	RF Power	Typical Range**	Power
A1	Low Cost, Single Analog Sensor interface (4-20mA or 1-5V)	10 mW	¼ Mile	Battery
MC1D1	Class 1 Division 1 unit with Hart, 4-20 mA, 1-5 V and DIO.	10 mW	1+ Mile	Battery
D2	Low Cost, 2 Digital Inputs to 2kHz Class 1 Div 2	10 mW	¼ Mile	Battery
A2D1	Long Range, 2 Analog Sensors (4-20 mA or 1-5V) 1 Digital Input to 2kHz	300 mW	2-3 Miles	Battery
Hart	Long Range, Hart Multi Drop and 1 Digital Input	300 mW	2-3 Miles	Battery
Modbus in a Stick	Long Range, Modbus-in-a-Stick™ Class 1 Div 2	500 mW	3-4 Miles	6-36 VDC*
Modbus in a Stick with File Transfer	Long Range, Modbus –in-a-Stick w/ File Transfer (Custody file extraction) Class 1 Div 2	500 mW	3-4 Miles	6-36 VDC*
Counter In a Stick	Long Range, Counter-in-a-Stick, 2 Digital IO, Optional Relay IF Board	500 mW	3-4 Miles	6-36 VDC*
Wiegand	Long Range, Wiegand-in-a-Stick, designed for card readers	500 mW	3-4 Miles	6-36 VDC
Camera	Long Range, Camera Node	300 mW	2-3 Miles	Battery
Gateway In A Stick	Long Range, Gateway-in-a-Stick, RS 485/232 Class 1 Div 2	500 mW	3-4 Miles	6-36 VDC

* 6-36V nodes can optionally be battery powered except for the Gateway

** Typical ranges for real world applications. Significantly longer ranges are possible with careful location.

SignalFire Telemetry System Node Interfaces

Node	4-20 mA	1-5V	Hart	Modbus	Digital Input	Digital Output	Other
A1	X	X					
MC1D1	X	X	X		X		
D2					X		
A2D1	X	X			X		
Hart			X		X		
Modbus in a Stick				X			
Modbus in a Stick with File Transfer				X			File Transfer
Counter In a Stick					X	X	
Wiegand							Wiegand
Camera							Camera
Gateway In A Stick				X			



SIGNALFIRE
wireless telemetry

SignalFire Remote Sensing System Hazardous Area, Multiple Input System

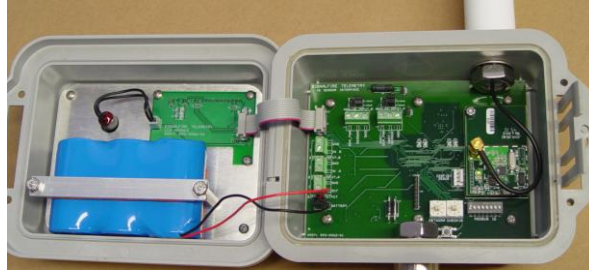

- **Class 1 Division 1 Intrinsically Safe System**
- **Battery Powered - Powers System and Sensor for up to 3 years**
- **Multiple Inputs**
 - **1 Multi Drop Hart ® Channel**
 - **2 4-20 mA or 1-5V Channels**
 - **2 Digital Inputs Channels**
 - **1 Digital Output Channel**
- **Digital Display**
- **Integrated High Gain Omni Directional Antenna**
- **Rugged Watertight Enclosure**
- **1+ Mile Range**
- **Sensor Independent**
- **Part of the SignalFire Remote Sensing System Mesh Network**
- **½” NPT Wiring/Conduit Interface**
- **915 MHz, FHSS Radio**

Technical Specifications

Operating Temp	-40C to 60C
Humidity	0% - 100% Condensing
Power	3 X D Lithium Battery Pack. Field Replaceable. Class 1, Division 1 Certified when used with SignalFire System. In Situ replacement does not require a work ticket.
Sensor Power	18V for 4-20 mA Current Loop or Hart Sensors. Sensor power is provided from the system, no need for external sensor power, no barriers required.
Battery Life	1-4 years depending on the number and type of sensors and reporting frequency
Data Interface	Wireless – Available as Modbus Registers at Gateway
Supported Sensor Interfaces	Hart (up to 4 devices), 4-20 mA Current Loop, 1-5 Volt, Digital Input (State, Counter ,Totals, Frequency), Digital Output (TTL Level)
Display	Externally visible display shows communications status and sensor readings
Data Update Rates	User Selectable Rotary Switch from 5 sec to 2 hours
Radio Power	10 mW
Antenna Type	External Weather Resistant, Omnidirectional
Antenna Gain	5dB
Receive Sensitivity	-105 dB
Frequency	902-928 MHz, FHSS, License Free ISM Band Compliant with FCC Part 15
Range	1+ Mile (Line of Sight, Real World)
Networks	Up to 64 separate networks. Rotary Switch Selectable
Enclosure	Fiberglass Reinforced UV Stabilized Plastic
Intrinsically Safe	Class 1, Division 1, Temp Code T3, Groups C&D. Conforms to UL Std. 913, Certified to Can/CSA Std C22.2 No. 157
Internal Diagnostics	Battery Voltage, Signal Strength, Error Conditions



SignalFire Remote Sensing System

SFRSS-A1 Low Cost Wireless Analog Sensing Module



- **Monitor:**
 - 4-20 mA current loop sensor or;
 - 1-5 V Sensor
- Powers sensor and radio for years with an internal battery
- Low Cost < 60 ft of installed conduit
- Rugged design for demanding outdoor environments
- Up to 1/2 Mile Range
- Automatically configures as a star or mesh network
- Simple to install and maintain

Technical Specification

4

Operating Temp	-40C to 70C
Humidity	0% - 100% Condensing
Power	3 X D Lithium Battery Pack. Field Replaceable. In Situ replacement does not require a work ticket.
Sensor Power	12.5V for 4-20 mA Current Loop or 1-5V Sensors. Sensor power is provided from the system, no need for external sensor power
Battery Life	1-4 years depending on the number and type of sensors and reporting frequency
Data Interface	All readings are converted to Modbus registers and stored in the Gateway
Supported Sensor Interfaces	4-20 mA Current Loop 1-5 Volt
Data Update Rates	User Selectable Rotary Switch from 5 sec to 2 hours
Radio Power	10 mW
Antenna Type	External Weather Resistant, Omnidirectional
Antenna Gain	-5db
Receive Sensitivity	-105 dB
Frequency	902-928 MHz License Free ISM Band Compliant with FCC Part 15
Range	Up to 1/2 Mile (Line of Sight)
Networks	Up to 64 separate networks. Rotary Switch Selectable
Enclosure	UV Stabilized Polycarbonate, NEMA 4X Rated
Safety Rating	Class 1, Division 2, Temp Code T5, Groups C&D. Conforms to UL Std. 61010-1 ANSI/ISA Std 12.12.01,, Certified to Can/CSA Std C22.2 No. 213 and Can/CSA Std No. 61010-1
Internal Diagnostics	Battery Voltage, Signal Strength, Error Conditions



SignalFire Remote Sensing System

SFRSS-A2 Wireless Analog Sensing Module

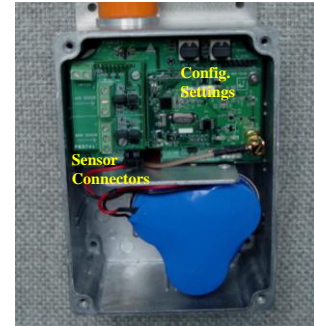

- **Monitor:**
 - **4-20 mA current loop sensors**
 - **1-5 V Sensors**
 - **Digital Input/Counter**
 - **Powers sensor and radio for years with a battery**
 - **Rugged design for demanding outdoor environments**
 - **Up to 3 Mile Range**
 - **Automatically configures as a star or mesh network**
- Simple to install and maintain**

Technical Specifications

Operating Temp	-40C to 70C
Humidity	0% - 100% Condensing
Power	3 X D Lithium Battery Pack. Field Replaceable.
Sensor Power	12.5 or 18V Jumper selectable for 4-20 mA Current Loop or 1-5V Sensors. Sensor power is provided from the system, no need for external sensor power
Battery Life	1-4 years depending on the number and type of sensors and reporting frequency
Data Interface	All readings are converted to Modbus registers and stored in the Gateway
Supported Sensor Interfaces	Supports 2 Analog Inputs and 1 Digital Input 4-20 mA Current Loop 1-5 Volt Digital Input
Data Update Rates	User Selectable Rotary Switch from 5 sec to 2 hours
Radio Power	300 mW
Antenna Type	External Weather Resistant, Omnidirectional
Antenna Gain	5 dB
Receive Sensitivity	-105 dB
Frequency	902-928 MHz License Free ISM Band Compliant with FCC Part 15
Range	Up to 3 Miles (Line of Sight)
Networks	Up to 64 separate networks. Rotary Switch Selectable
Enclosure	Aluminum, NEMA 4X Rated
Internal Diagnostics	Battery Voltage, Signal Strength, Error Conditions



SignalFire Remote Sensing System

SFRSS-H Wireless System with Hart® Interface

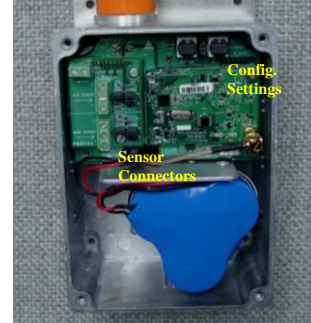

- **Monitor:**
 - Up to 4 Hart® sensors
 - Digital Input/Counter
- **Rugged design for demanding outdoor environments**
- **Powers sensor and radio for years with a battery**
- **1-3 Mile Range**
- **Automatically configures as a star or mesh network**
- **Simple to install and maintain**

Technical Specifications

Operating Temp	-40C to 70C
Humidity	0% - 100% Condensing
Power	3 X D Lithium Battery Pack. Field Replaceable.
Sensor Power	12.5 or 18V Jumper selectable
Battery Life	1-4 years depending on the number and type of sensors and reporting frequency
Data Interface	All readings are converted to Modbus registers and stored in the Gateway
Supported Sensor Interfaces	Up to 4 Hart sensors 1 Digital Input
Data Update Rates	User Selectable Rotary Switch from 5 sec to 2 hours
Radio Power	300 mW
Antenna Type	External Weather Resistant, Omnidirectional
Antenna Gain	5 dB
Receive Sensitivity	-105 dB
Frequency	902-928 MHz License Free ISM Band Compliant with FCC Part 15
Range	Up to 3 Miles (Line of Sight)
Networks	Up to 64 separate networks. Rotary Switch Selectable
Enclosure	Aluminum, NEMA 4X Rated
Internal Diagnostics	Battery Voltage, Signal Strength, Error Conditions



SignalFire Remote Sensing System

SFRSS Modbus-in-a-Stick



- Provides a wireless interface to remote Modbus sensors
 - RS 485 interface between sensor and SFRSS Modbus-in-a-Stick
 - Automatically reads and transmits sensor registers at user definable intervals
 - Writes Modbus registers
 - Message forwarding capability
 - Rugged design for demanding outdoor environments
 - Low Power Consumption
 - 1-3 Mile Range
- Simple to install and maintain

Technical Specifications

Operating Temp	-40C to 85C
Humidity	0% - 100% Condensing
Power	6-36 VDC, (Battery Power Optional)
Data Interface	RS 485 or RS 232 Modbus Interface, RS 232 interface for file transfer (Model MT) All readings are converted to Modbus registers and stored in the Gateway
Data Update Rates	User Configurable with Configuration Utility
Radio Power	500 mW
Antenna Type	Omnidirectional
Antenna Gain	5dB
Receive Sensitivity	-105 dB
Frequency	902-928 MHz License Free ISM Band Compliant with FCC Part 15
Range	1-3 Miles (typical) much longer with careful placement
Networks	Up to 64 separate networks.
Enclosure	Weather Tight, Integrated Electronics and Antenna. NEMA 3R
Safety Rating	Intrinsically Safe, Class 1, Division 2 Groups C and D, T5
Internal Diagnostics	Line Voltage Signal Strength Error Conditions



SignalFire Remote Sensing System

SFRSS Counter-in-a-Stick



- Provides a wireless interface to remote counting sensors such as flow meters
- Two Digital interfaces, Dry Contact, Open Collector and other interfaces
- Calculates
 - Total Counts
 - Instantaneous Frequency
 - Frequency Since Last Read
 - State
- Measures to 2 KHz
- Optional Relay Control
- Message forwarding capability
- Rugged design for demanding outdoor environments
- Low Power Consumption
- 1-3 Mile Range

Simple to install and maintain

Technical Specifications

Operating Temp	-40C to 70C
Humidity	0% - 100% Condensing
Power	6-36 VDC, (Battery Power Optional)
Data Interface	Digital Input/Output. Optional Relay Control Board. Measures State, Counts and Frequency
Data Update Rates	User Configurable with Configuration Utility
Radio Power	500 mW
Antenna Type	Omnidirectional
Antenna Gain	5dB
Receive Sensitivity	-105 dB
Frequency	902-928 MHz License Free ISM Band Compliant with FCC Part 15
Range	1-3 Miles (Line of Sight)
Networks	Up to 64 separate networks.
Enclosure	Weather Tight, Integrated Electronics and Antenna.
Internal Diagnostics	Line Voltage Signal Strength Error Conditions



SignalFire Remote Sensing System

SFRSS-D2 Low Cost Wireless Digital Input Module



- Provides a wireless interface to remote counting sensors such as flow meters
- Two Digital Inputs, Dry Contact, Open Collector and other interfaces
- Calculates
 - Total Counts
 - Frequency
 - State
- Measures to 2 KHz
- Optional Cameron MC2 interface
- Rugged design for demanding outdoor environments
- Low Power Consumption
- 1-3 Mile Range
- Simple to install and maintain

Technical Specifications

Operating Temp	-40C to 70C
Humidity	0% - 100% Condensing
Power	3 X D Lithium Battery Pack. Field Replaceable. In Situ replacement does not require a work ticket.
Digital Interface	2 Digital Inputs, Measures State, Counts and Frequency. Optional Cameron MC2 Interface
Battery Life	1-4 years depending on the number and type of sensors and reporting frequency
Data Interface	All readings are converted to Modbus registers and stored in the Gateway
Supported Sensor Interfaces	4-20 mA Current Loop 1-5 Volt
Data Update Rates	User Selectable Rotary Switch from 5 sec to 2 hours
Radio Power	10 mW
Antenna Type	External Weather Resistant, Omnidirectional
Antenna Gain	-5db
Receive Sensitivity	-105 dB
Frequency	902-928 MHz License Free ISM Band Compliant with FCC Part 15
Range	Up to 1/2 Mile (Line of Sight)
Networks	Up to 64 separate networks. Rotary Switch Selectable
Enclosure	UV Stabilized Polycarbonate, NEMA 4X Rated
Safety Rating	Class 1, Division 2, Temp Code T5, Groups C&D. Conforms to UL Std. 61010-1 ANSI/ISA Std 12.12.01,, Certified to Can/CSA Std C22.2 No. 213 and Can/CSA Std No. 61010-1
Internal Diagnostics	Battery Voltage, Signal Strength, Error Conditions



SignalFire Remote Sensing System

Gateway-In-A-Stick Integrated Gateway and High Gain Antenna









- RS 232/485 interface
- Stores the most recent readings of all nodes in the network in Modbus format
- Times out readings from off line sensors
- Manages outbound communications
- Reduced Power Consumption
- Integrated High Gain Omni Directional Antenna and Gateway Electronics
- Mount with clamps, brackets or standard electrical/plumbing Fittings
- 5000+ Meter Range
- Automatically configures as a star or mesh network
- Designed for Rugged Outdoor Environments

Technical Specifications

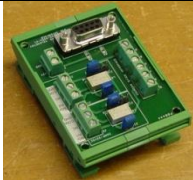
Operating Temp	-40C to 85C
Humidity	0% - 100% Condensing
Power	6-36 VDC, (Battery Power Optional)
Data Interface	RS 485 Modbus Interface, RS 232 interface for file transfer (Model MT) All readings are converted to Modbus registers and stored in the Gateway
Data Update Rates	User Configurable with Configuration Utility
Radio Power	500 mW
Antenna Type	Omnidirectional
Antenna Gain	5dB
Receive Sensitivity	-105 dB
Frequency	902-928 MHz License Free ISM Band Compliant with FCC Part 15
Range	1-3 Miles (typical) much longer with careful placement
Networks	Up to 64 separate networks.
Enclosure	Weather Tight, Integrated Electronics and Antenna. NEMA 3R
Safety Rating	Intrinsically Safe, Class 1, Division 2 Groups C and D, T5
Internal Diagnostics	Line Voltage Signal Strength Error Conditions

Accessories

Batteries	
	3XD Replacement Battery Pack For use with the A2, Hart, A1, D2 and MC2 units
	Intrinsically Safe Replacement Battery Pack For use with the Multi Input System
	IQ Smart Battery Pack For use with the A2, Hart, D2 and MC2 units as part of the IQ Solar Charging System
Interface Cards	
	Digital Interface Module - For Use with the Counter-in-a-Stick. <ul style="list-style-type: none"> • Can be configured for input only or output using relays. • 9 Pin Connector for Configuring the Counter-in-a-Stick. • Din Rail Mount
	Connector Break Out Board Used to Configure and provide easy connection to In-a-Stick products <ul style="list-style-type: none"> • LED's show status • Connectors for Power, RS 485 and RS 232 • Din Rail Mount
Tools	
	Node Checker A set up and network health tool <ul style="list-style-type: none"> • Can query the status of any node in the network • Provides Signal Information • Recommended for all installers
	Adapter Cable for A2, Hart, Multi Input, A1 and D2 RS 232 Adapter Cable Connects to board mounted 4 pin header for code loads, and configuration
	USB to Serial Adapter



SIGNALFIRE
wireless telemetry

WWW.Signal-Fire.com

Contact: Al Hamilton

Al.Hamilton@signal-fire.com

978 212 2868

508 527 3952