

F-DVR200 User Manual	Document Version	Page
	V1.0.0	
	Product Name: F-DVR200	Total:74

F-DVR200 User Manual





Files Revised Record

Date	Version	Remark	Author
2016-12-19	V1.0.0		Wangwr/WSP

Copyright Notice

All contents in the files are protected by copyright law, and all copyrights are reserved by HongKong Four-Faith Communication Technology Co., Ltd. Without written permission, all commercial use of the files from Four-Faith are forbidden, such as copy, distribute, reproduce the files, etc., but non-commercial purpose, downloaded or printed by individual (all files shall be not revised, and the copyright and other proprietorship notice shall be reserved) are welcome.

Trademark Notice

Four-Faith、四信、、、 are all registered trademarks of HongKong Four-Faith Communication Technology Co., Ltd., illegal use of the name of Four-Faith, trademarks and other marks of Four-Faith is forbidden, unless written permission is authorized in advance.

Contents

Chapter 1 Brief Introduction of Product.....	5
1.1 General.....	5
1.2 Product Feature.....	6
1.3 Product Specification.....	9
1.4 IR operation instructions.....	17
Chapter 2 Installation Introduction.....	19
2.1 Overview.....	19
2.2 Encasement List.....	19
2.3 Installation and Cable Connection.....	20
2.4 power connection.....	25
2.5 LED indicator light Introduction.....	27
Chapter3 WEB param config.....	29
3.1 config connect.....	29
3.2 login to config page.....	29
3.2.1 pc local ip config.....	29
3.2.2 install Browser plugin.....	29
3.2.3 login to config page.....	30
3.3 manage and config.....	31
3.3.1 video operation.....	31
3.3.2 record task setting.....	36
3.3.3 system settings.....	38
3.3.4 system manage.....	49
3.3.5 system information.....	54
Chapter4 UI config param.....	56
4.1 system setting.....	56
4.1.1 login.....	56
4.1.2 record setting.....	57
4.1.3 record search.....	57
4.1.4 encode setting.....	59
4.1.5 network setting.....	60
4.1.6 server setting.....	61
4.1.7 OSD setting.....	61
4.1.8 date setting.....	62
4.1.9 ptz setting.....	62
4.1.10 capture setting.....	63
4.2 system manage.....	63
4.2.1 general setting.....	63
4.2.2 self maintaine.....	64
4.2.3 account.....	64
4.2.4 disk manage.....	64
4.2.5 restore.....	65

4.2.6 record export.....	65
4.2.7 bootmode setting.....	65
4.2.8 reboot.....	66
4.2.9 alarm setting.....	66
4.2.10 version.....	67

Chapter 1 Brief Introduction of Product

1.1 General

F-DVR200 is an embedded linux operation system device, it research and development by four-faith company. F-DVR200 have 8 channel video and audio input, support network 3G/4G/WIFI/LAN, positioning by gps/Compass, local large storage media with safely, protect disk vibration, flexible choices for video channels and encord plan.

This product has been widely used for audio and video monitoring in public transport, tourism, industrial sectors, such as city bus, bus station, custom bus, tour bus, long-distance passenger bus, tourist attractions, industrial minerals and other places.

Application Topology

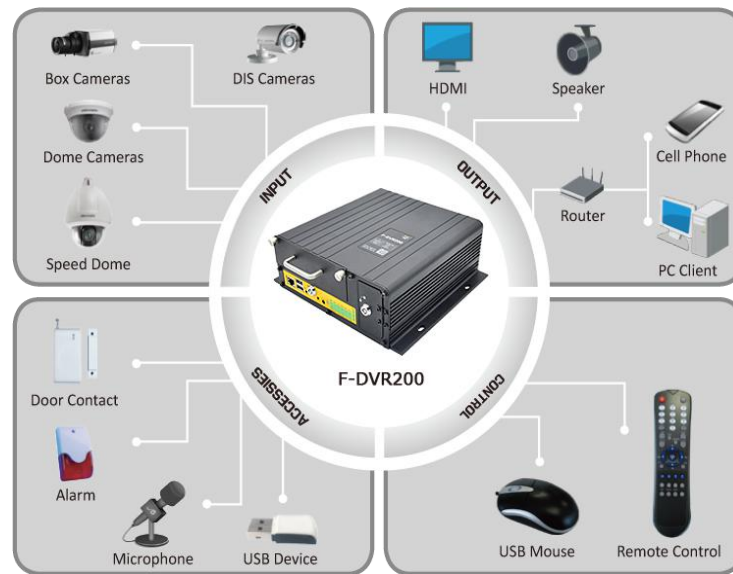

1.2 Product Feature

Design for Vehicle Application

- High-powered 32bits CPU
- Vehicle power supply design, support under-voltage, over-voltage, over-current, reverse connection, short circuit, surge protection
- Wide Power range(DC 9~36V)
- Wide Operating Temperature(-35~+75°C)
- Aviation plug for power input
- Metal shell, high heat radiating and anti collision performance
- Shockproof design,suitable for vehicle vibrating environment
- Security structure design for TF/SIM card

Stability and Reliability

- Support hardware and software WDT to ensure the stability of the system
- Support auto recovery mechanism, including online detect, auto redial when offline to make router always online
- Data storage with hard disk, ensure the data security and stability on high speed read and write
- Ethernet port: 1.5KV magnetic isolation protection
- RS232/RS485/RS422 port: 15KV ESD protection
- SIM/UIM port: 15KV ESD protection
- Antenna port: lightning protection(optional)

High-performance

- 8 channels runtime video encode and audio encode, h.264 encode.low bitrate, better video quality
- Support 4 channels or 8 channels, choose by demand
- Support 4 channels or 8 channels replay and record
- Support 4 channels 1080p ipc input,support ipc event (md,od and so on) record.
- Support ipc snopshot ipc video record.
- Support USB/remote/local-web Update Firmware
- Support 485 interface
- Support 8 channel analog input (16 bit AD, Support voltage signal, range: 0~5V), 6 channel digit input, 6 channel digit ouput (2 channel for Relay driver)
- Rich led light, can quickly grasp the machine running state
- Matched server platform and client
- Mulit-transfer media,used for every application scenarios
- Useful rate control, keep stability video transfer for wireless network
- Mulit record export, USB local export,remote web download,local web download
- Removable hard-disk, connect hard-disk to pc by usb, used for export and replay record
- Support mulit record mode: IR record,timer record, move detect record, alarm record
- 6 works in sametime: monitor, record, replay, bakeup, network-transfer, ptz
- Support double streams: main stream and sub stream. Main stream (big imagesize) use for local record
- Support stream use for netwrok-transfer to save network bandwidth when wireless
- Support video output use CVBS or HDMIinterface
- Storage media support hard-disk, SD card, Auto Override
- Support protect alarm record, can protect the important record
- Steady storage, power protection mechanism keep record complete, even lost power
- Low voltage protection
- Mulit boot mode: timer, ACC, ACC+timer, Even, IR

- Support IR control, support External infrared antenna
- Support wifi connect to server and transfer data
- Support local UI
- Support remote TTS(optional)
- Support remote voice talk
- Multit configuration parameter: local UI, local web, remote web
- Support NTP, RTC embedded
- Support multinet network switch, Configurable for Network priority
- Support the GPS/beidou positioning function (optional)

1.3 Product Specification

Video and audio Specification		
Item	Content	
Video	Input	8 channels D1 Electrical level: 1.0Vp-p, Impedance: 75Ω
	Output	1 channel CVBS Electrical level: 1.0Vp-p, Impedance: 75Ω PAL: D1 (704*576)
		1 channel HDMI 1024*768
Audio	Input	8 channel Linear Electrical level, Impedance: 1kΩ
	Output	1 channel Linear Electrical leve, Impedance : 600Ω
Code	Video Compression	H.264
	Image Resolution	PAL: D1/CIF NTSC: CIF/QCIF
	Video frame	PAL: 1-25fps
	Video rate	Network dynamic adjustment
	Stream type	Optional streaming video or compound flow
	Audio Compression	ADPCM
	Audio rate	32kpbs
	Voice intercom	ADPCM
Storage Specification		
Item	Content	
HDD Type	2.5' SATA HDD/SSD	
HDD Capacity	HDD: 500GB(optional, optional Extended to 2 TB)	
HDD Access	Standard 2.5 inch SATA interface, pluggable type	
HDD Protection	Shock absorber hard disk box	
SD Type	Standard SD/SDHC	
SD Capacity	64GB(optional)	

SD Access	Standard SD/SDHC card slot, support hot plug
Cellular Specification	
Item	Content
Cellular Module	High-performance cellular module (optional single module, double module or no module)
Standard	Can support: TDD-LTE/FDD-LTE/EVDO/WCDMA/TD-SCDMA/CDMA1X/GPRS/EDGE Optional support:single-mode,multi-mode or All network communication
Bandwidth	FDD LTE(DL:100Mbps,UL:50Mbps) TDD LTE(DL:61Mbps,UL:18Mbps) CDMA2000 1X EVDO Rev A (DL:3.1Mbps,UL:1.8Mbps) WCDMA(DL:42Mbps,UL:5.76Mbps) TD-SCDMA(DL:4.2Mbps,UL:2.2Mbps)
TX power	<24dBm
RX sensitivity	<-109dBm
GPS Specification	
Item	Content
GPS Module	Industrial GPS module(optional beidou module)
Receiver Type	50-channle GPS L1(1575.42MHz)C/A code SBAS: WAAS,EGNOS,MSAS,GAGAN
Max. update rate	5 Hz
Accuracy	Position: 2.5m CPE SBAS: 2.0m CPE
Sensitivity	Tracking: -160dBm Reacquisition: -160dBm Cold starts: -146dBm
WIFI Specification	
Item	Content
Standard	IEEE802.11b/g/n, 2.4G,1T1R,AP model, Station model(optional)
Bandwidth	IEEE802.11b/g: 54Mbps(max) IEEE802.11n: 150Mbps(max)
Security	WEP, WPA, WPA2, etc. WPS (optional)
TX power	13dBm (11n), 14dBm (11g), 16dBm (11b)
RX sensitivity	<-73dBm@54Mbps
Hardware System	
Item	Content
CPU	High-performance ARM Cortex A9 CPU

FLASH	64MB(Extendable to 32MB)
DDR2	512MB(Extendable to 1GB)

Interface type

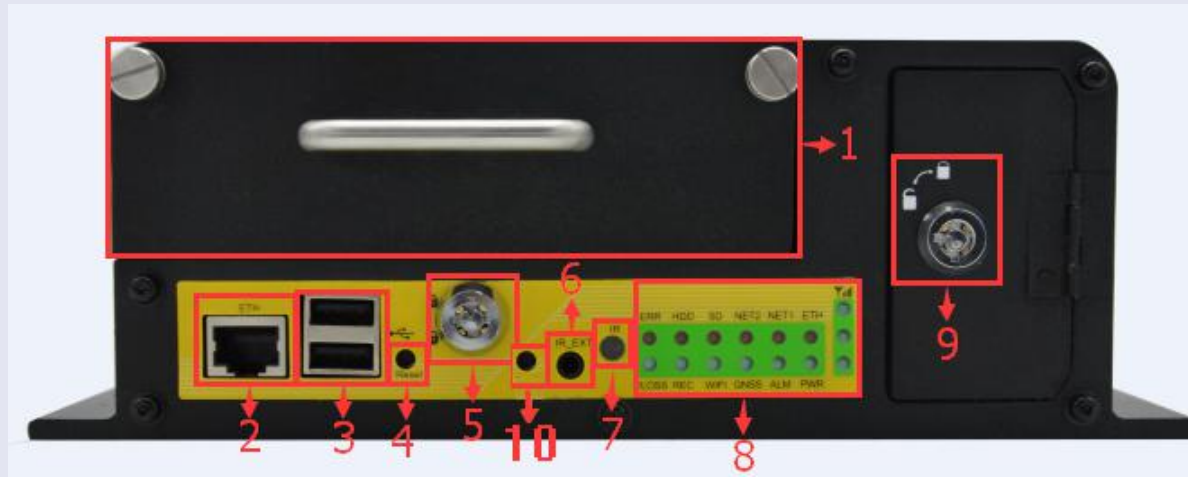

No.	Name	Content
1	HDD Box	Support a 2.5' SATA HDD/SSD, Insert or delete must hard disk lock is open
2	LAN	10/100 Mbps Ethernet interface
3	USB	2 USB2.0 interface
4	Reset	Reset button, press this button more than 0.1 seconds to reset the DVR devices
5	HDD Lock	Protect hard disk with power control equipment
6	IR-EXT	External infrared remote control interface
7	IR	Infrared remote control interface
8	Indicator	PWR: Power indicator ALM: Alarm indicator GNSS: GPS/beidou indicator WIFI: WIFI indicator REC: Store the video indicator VLOSS: Video loss of indicator ETH: Ethernet interface indicator NET1: Network 1 indicator NET2: Network 2 indicator SD: SD Card indicatort HDD: Hard disk indicator ERR: Error alarm indicator
9	Card Lock	Protect SD or SIM/UIM
10	Restore	Factory Restore

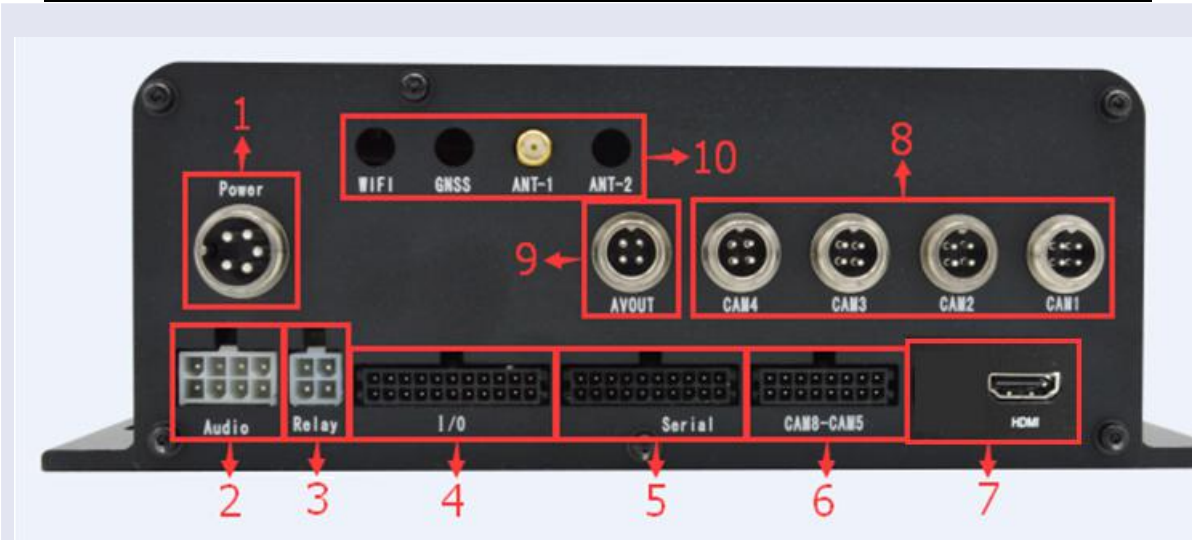

No.	Name	Content
1	Power	Power and start control interface, 5P aviation plug
2	Audio	Audio input, output and control interface, 5557-8P
3	Relay	2 Relay output interface, 5557-4P
4	I/O	6 DIN, 4 DOUT(OC), 8 AIN and Power output
5	Serial	RS232 communication interface, CAN bus, RS232 and RS485 bus and power output
6	CAM5-CAM8	5 ~ 8 channel video and audio input, output power
7	hdmi	Hdmi 1.3 interface
8	CAM1~CAM4	1 ~ 4 channel video and audio input, output power, 4P aviation plug
9	AVOUT	Video and audio output, 4P aviation plug
10	Antenna	SMA antenna interface, GNSS antenna, WIFI and 3 g / 4 g module antenna

Power supply

Item	Content
Standard Power	DC 12V/5A(optional DC 12V/8A)
Power range	DC 9~36V
Working current	<1100mA (12V)
Standby current	<170mA (12V)

Physical Characteristics

Item	Content
Housing	Metal shell, shock proof design
Dimensions	231x210x78 mm
Weight	3.22kg



Other Specification

Item	Content
Operating Temperature	-35~+75°C(-31~+167°F)
Storage Temperature	-40~+85°C(-40~+185°F)
Operating Humidity	95% (unfreezing)

Stitch definition

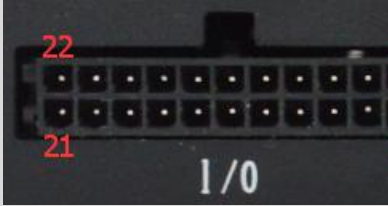
No.	Identification	Image	Definition	Description
1	Power	Type: 16M-5P 	1: DCIN+ 2: DCIN+ 3: DCIN- 4: DCIN- 5: ACCIN	Input voltage range: DC 9~36V ACCIN: Ignition control signal
2	Audio	Type: 5557-2*4P 	1: Aout-R 2: Aout-L 3: SPK+ 4: SPK- 5: SW 6: GND 7: MIC+ 8: MIC-	Aout: Dual channel TTS and local propaganda output, Power "2*25W/4Ω" SPK: Listening to the speaker Power "7.5W/8Ω" SW: Propaganda switch MIC: Intercom, propaganda input
3	Relay	Type: 5557-2*2P 	1: RelayA+ 2: RelayA- 3: RelayB+ 4: RelayB-	RelayA: First relay RelayB: Second relay Largest switching voltage: 30VDC/250VAC Largest switching current: 5A Largest switching power: 150W/1250VA

4	I/O	<p>Type: Spacing 3.0mm</p> 	<p>1: DIN2 2: DIN1 3: DIN4 4: DIN3 5: DIN6 6: DIN5 7: DOUT2 8: DOUT1 9: DOUT4 10: DOUT3 11: +5V 12: COM 13: +12V 14: AGND 15: AIN8 16: AIN7 17: AIN2 18: AIN1 19: AIN4 20: AIN3 21: AIN6 22: AIN5</p>	<p>DIN: Optical isolation digital input Logic 0: 0~3V, connect Logic 1: 5~30V, disconnect DOUT: Optical isolation OC output Drive current rating: 50mA Drive voltage rating: 35V AIN: Buffer 16 analog input 0~5V Voltage signal input 4~20mA Current signal input (optional) AGND: Analog input GND Note: Using DIN and DOUT, Must connect COM. IO Power / Serial Power: Support: 12V/2A Support: 5V/2A</p>
---	-----	--	---	--

5	Serial	<p>Type: Spacing 3.0mm</p> 	<p>1: +12V 2: +12V 3: GND 4: GND 5: +5V 6: +5V 7: RS485A1 8: RS485B1 9: RS485A2 10: RS485B2 11: CANL 12: CANH 13: RXD1 14: TXD1 15: RXD2 16: TXD2 17: RXD3 18: TXD3 19: RXD4 20: TXD4</p>	<p>Serial Power / IO Power: Support: 12V/2A Support: 5V/2A RS485A1,RS485B1(TXD2,RXD2 optional), RS485 Camera console. RS485A2,RS485B2(TXD4,RXD4 optional), Optional extension. TXD1,RXD1: Main MCU Debug TXD3,RXD3: Div MCU Debug CANH,CANL: CAN Bus interface, Optional extension.</p>
6	CAM5-CAM8	<p>Type: Spacing 3.0mm</p> 	<p>1: AIN5 2: +12V 3: VIN5 4: GND 5: AIN6 6: +12V 7: VIN6 8: GND 9: AIN7 10: +12V 11: VIN7 12: GND 13: AIN8 14: +12V 15: VIN8 16: GND</p>	<p>1~4: 5 channel Video and audio input 5~8: 6 channel Video and audio input 9~12: 7 channel Video and audio input 13~16: 8 channel Video and audio input</p>

7	hdmi	Type:type-a 	Hdmi1.3 interface	Video output
8	CAM1~CAM 4	Type: 12M-4P 	1: +12V 2: GND 3: AIN 4: VIN	Video and audio input channel
9	AVOUT	Type: 12M-4P 	1: +12V 2: GND 3: AOUT 4: VOUT	Video and audio output channel
10	Antenna	Type: SMA 	WIFI: WIFI Antenna GNSS: GNSS Antenna ANT-1: Main 3G/4G Antenna ANT-2: Diversity 3G/4G Antenna	

1.4 IR operation instructions

F-DVR200 IR key Figure:



IR key function Figure:

key	display	function
Power	Power	Power on/off device
Login	Login	Login UI
Rec	Rec	IR record
Stop	Stop	Stop IR record
Edit+/Edit-	Edit+/Edit-	Controler multi value select (like date controler year select and so on)
Back	Back	Back or exit
Net	Net	Shortcuts for net config
Switch	Switch	1.UI switch focus from one control to another control . 2.switch multi video screen with one video screen
Zoom in/Zoom out	Zoom in/Zoom out	Zoom in/out for ptz
Focus+/Focus-	Focus+/Focus-	Change focus for ptz
Up/Down/Left/Right	Up/Down/Left/Right	Up/Down/Left/Right
Enter	Enter	Submit select
number	-	Number , character or special character input. keymap: {'1','a','b','c'},{'2','d','e','f'},{'3','g','h','i'},{'4','j','k','l'}, {'5','m','n','o'},{'6','p','q','r'},{'7','s','t','u'},{'8','v','w','x'}, {'9','y','z','.'}, {'0','_','*','#'},
del	del	Delete input text.
Ptz	-	Shortcuts for ptz operation
play	Play	Pause or play record
Prev/Next	Prev/Next	Play prev/next record
Volume+/Volume	Volume+/Volume	Volume control
iris+/iris-	iris+/iris-	Iris control fot ptz
Frame play	Frame play	When record replay,Play next Frame when chick.
forward/rewound	Time+/Time-	fast-forwarded or rewind the record replay.
Stop	Stop	Stop record replay

Chapter 2 Installation Introduction

2.1 Overview

F-DVR200 must be installed correctly before they achieve the design features, the device must be installed in a generally recognized by the Company under the guidance of a qualified engineer.

Precautions:

Forbid to install when device power on.

2.2 Encasement List

For safe transport, usually we need a reasonable package, when you are out of the box, please take good care of packing materials for use in future transport needs. It includes the following elements:

It includes the following elements:

- ✧ F-DVR200 host
- ✧ 1 (or 2) Wireless cellular antenna (SMA male head)
- ✧ 1 GPS antenna (SMA male head) (optional)
- ✧ 1 WIFI antenna (SMA female head) (optional)
- ✧ 1 Power line
- ✧ 1 Power Adapter (optional)
- ✧ 5 aviation plug to video/audio input line
- ✧ 1 video/audio extern input line (optional)
- ✧ 1 power amplifier output line (optional)
- ✧ 1 Relay output line (optional)
- ✧ 1 gather, control line (optional)
- ✧ External audio pickup (optional)
- ✧ 1 External infrared remote control line (optional)
- ✧ 1 Crosslink Ethernet Cable
- ✧ 1 serial line
- ✧ 1 IR control
- ✧ 4 Keys for device lock
- ✧ Product certification
- ✧ Warranty Card

2.3 Installation and Cable Connection

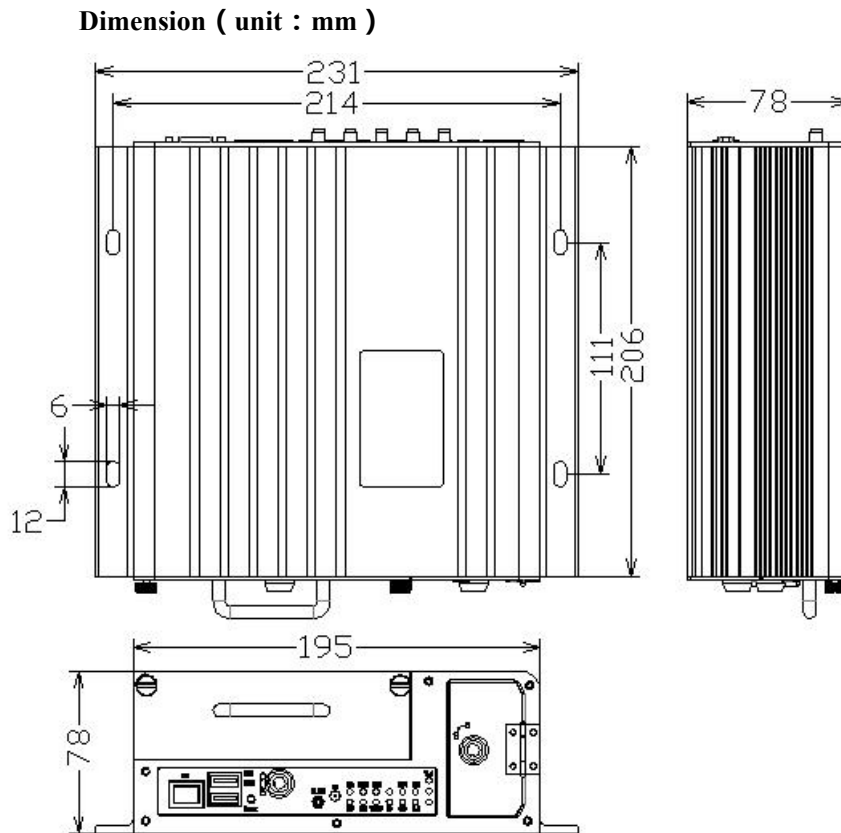

antenna Installation:

- 1 Wireless cellular antenna interface is SMA female head (marks:"ANT") , use provided Wireless cellular antenna (SMA male head) spin to this interface,keep spin closed.
- 2 WIFI antenna interface is SMA male head (marks:"WIFI") , use provided wifi antenna (SMA female head) spin to this interface,keep spin closed.
- 3 GNSS antenna interface is SMA female head (mark:"GNSS"). use provided GNSS antenna (SMA male head) spin to this interface,keep spin closed.

Precautions : Wireless cellular antenna ,WIFI antenna and GNSS antenna must spin to corresponding interface,otherwise device cannot work Normal .

SIM/UIM card Installation:

When install or tack out SIM/UIM card, open Cover panel use provided key,

- 1 Insert into the point left of SIM/UIM card connector Use sharp object, like below Figure show



2 put card into the connector like below Figure show :



3 Put back SIM/UIM card connect to there slot ,like below Figure show :
Make sure insert to the end of slot.



SD card Installation:

Install SD card, open Cover panel use provided key, insert SD card into the slot mask "sd", like below Figure show :



SD card must Make sure insert to the end of slot.

Lock Cover panel.



Hard disk install:

Turn hard disk lock to open position ,Then counterclockwise unscrew the captive screws on the hard disk box, like below Figure show :



pull out the hard disk box , like below Figure show :

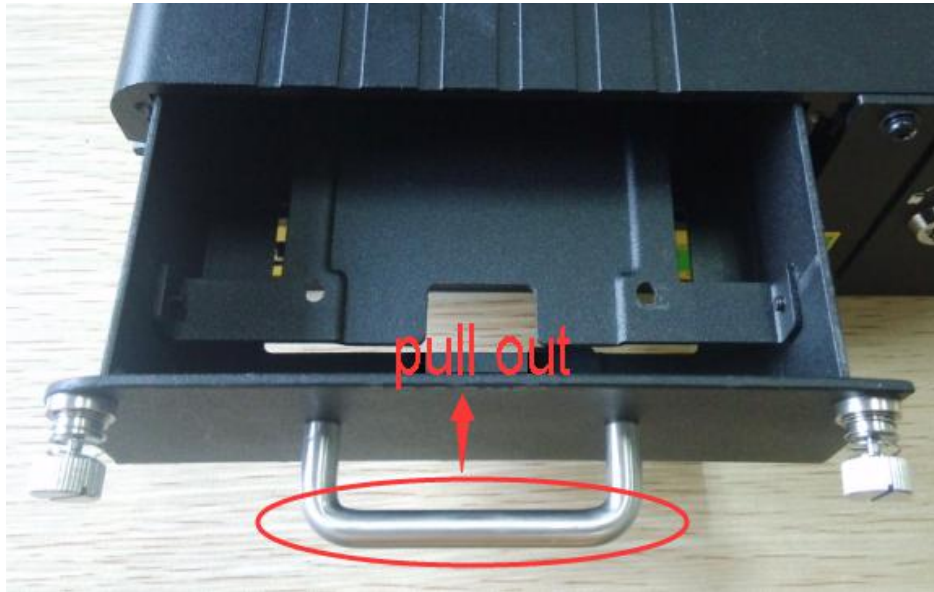

Put 2.5 inch SATA hard disk insert to corresponding interface like below Figure show :



Lock the hard disk with 4 M3*5 screw .



Put back hard disk box to the device , spin the screw , turn ard disk lock to close position, hard disk installer end.



2.4 power connection

1 F-DVR200 used for no Vehicle Application,if used for 4 channel Monitor, we recommend use 12VDC/5A Adapter , if used for 8 channel monitor, we recommend us 12VDC/8A or bigger adapter.

2 F-DVR200 used for Vehicle Application,connect to power of car support,device support 12VDC and 24VDC.

Connect instruction:

With different demand , F-DVR200 provide two work mode,different power connect whit

different work mode .

- acc mode ,delay poweroff

F-DVR200 power when card acc on, device keep poweron (preset time) when acc off,

Device power depend on acc signal;

- Timer mode

F-DVR200 device poweron and poweroff with we preset timer, whole work independent the power input.

acc mode ,delay poweroff

acc mode depend on acc signal:device “key+” connect to acc switch.

DC+ connect to positive pole of battery.DC- connect to negative pole of battery.DC,connect like below Figure show

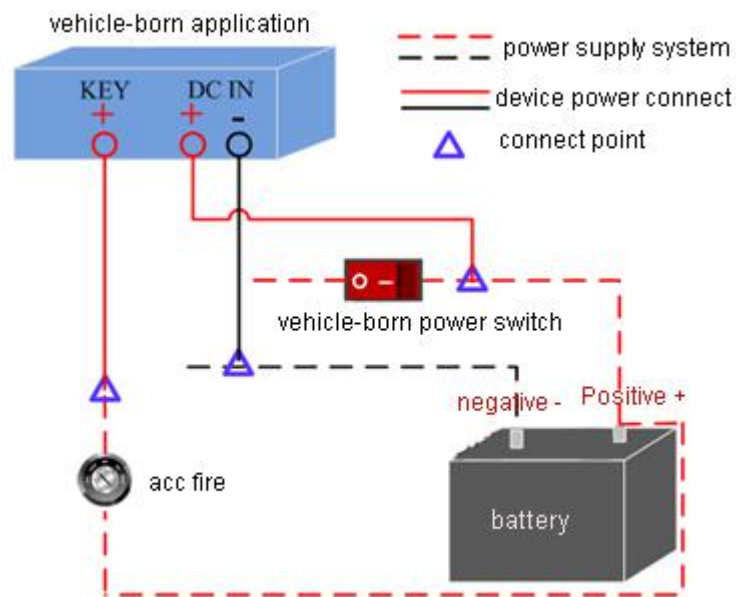

Normal mode

Normal mode:device “key+” connect to positive pole of battery,DC+ connect to positive pole of battery.DC- connect to negative pole of battery.DC,connect like below Figure show

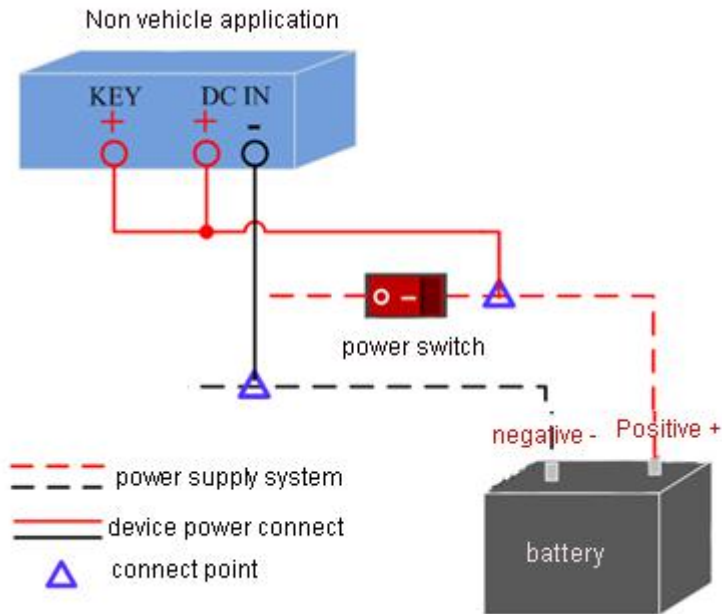

2.5 LED indicator light Introduction

F-DVR200 provided below led indicator light:

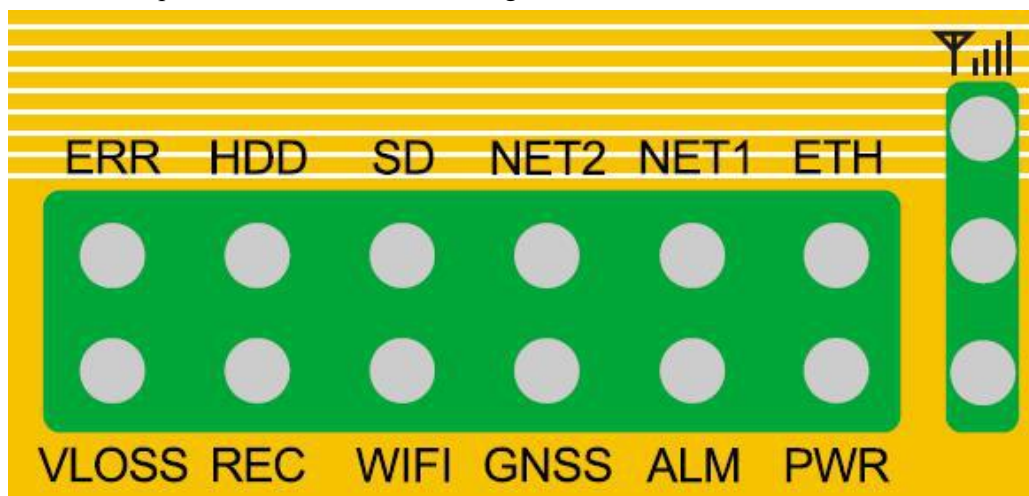

LED indicator light Introduction like below Figure :

light	status	Introduction
PWR	on	Device power on
	off	Device power off
ERR	flicker	Record error
	off	Record ok

3G signal 1-3	on	Signal value
	off	Signal value
ETH	on	Lan connect
	off	Lan disconnect
NET1	on	Device connect to video server
	flicker	Device can access to the Internet but cannot connect to video server
	off	Device cannot access to the Internet
NET2	on	Gps connect to server
	off	Gps cannot connect to server
USB/SD	on	Usb storage found
	flicker	Usb storage write
	off	Have no usb storage
HDD	flicker	hard disk read or write
	off	Hard disk no found
GNSS	on	GPS position success
	flicker	GPS antenna connect but position no connect
	off	GPS antenna disconnect
WIFI	on	Wifi connect
	off	Wifi disconnect
VLOSS	on	All video channel loss
	flicker	A part of video channel loss
	off	All video channel connect ok
ALM	on	Trigger alarm event
	off	No alarm event
REC	on	All channels recording
	flicker	A part of channels recording
	off	No recording

Chapter3 WEB param config

3.1 config connect

- ✧ Befor config dvr param from web ,we should connect dvr to our LAN through Crosslink Ethernet Cable or wifi. When use wifi connect you must trun on and config wifi ssid and passwd.

3.2 login to config page

3.2.1 pc local ip config

Config PC ipaddr to 192.168.1.9(or other ip in 192.168.1network segment) , netmask : 255.255.255.0, defalut gateway: 192.168.1.1.

3.2.2 install Browser plugin

Execute provided F-DVR200plugin.exe,install to computer
This plugin support IE (version big than 9)



F6934plugin.exe

3.2.3 login to config page

This chapter introduce function of device param config pages.you can config device param through the device provide local web config page.

The Config and operat contains five parts:video operat,record task,system config,system manage,system information.

Video page include local live video show,search record,replayrecord,download or export record.

Record task:config record task.

System config include pages: general settings, codesettings, networking, servers, output settings, capture, alarm set, datatime set, gensor setting, wifi auto upload, Roi.

System manage include pages: harddisk manage, account, auto maintenance , restore default, firmware upgrade , boot mode, reboot, cmddebug.

System information include pages: system log ,virsion ,log info.

accessto device ip use browser,enter username and passwd ,default adminitrotar username and passwd are “admin”. Default operator username and passwd ar “operator” ,different authority for different user.

(user manage in account page)



The home page like below page:

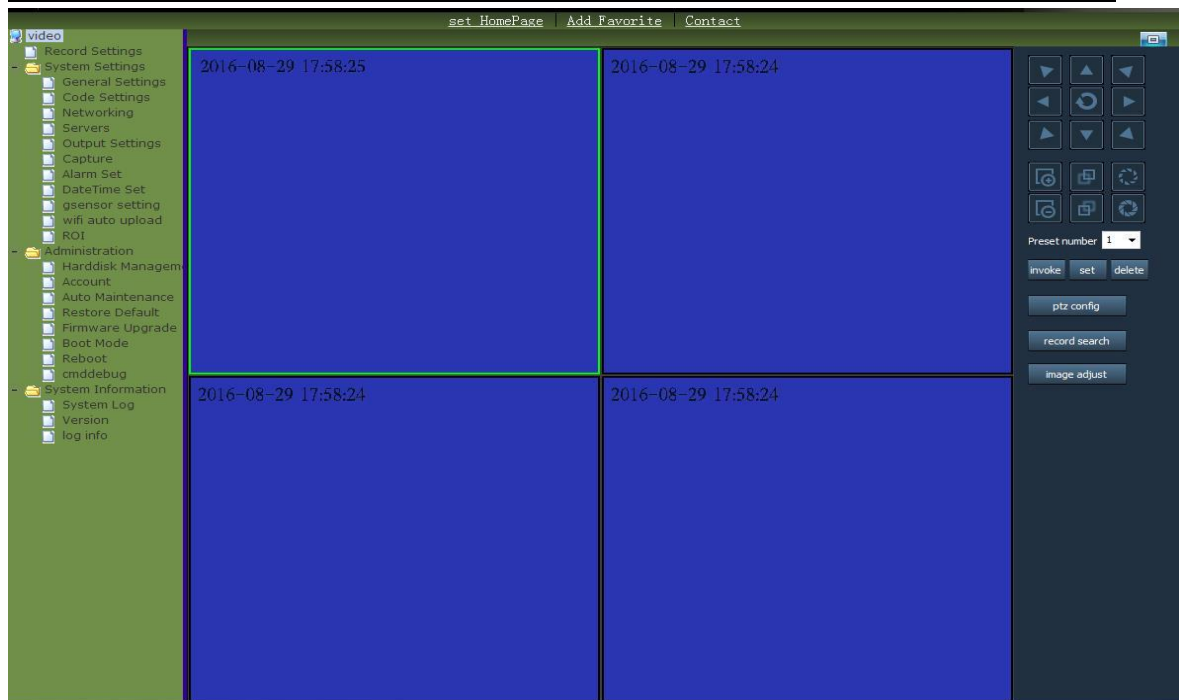

3.3 manage and config

3.3.1 video operation

3.3.1.1 local live video view

The plugin auto show 4 or 8 channels(general settings) video when the page open,

3.3.1.2 ptz operation

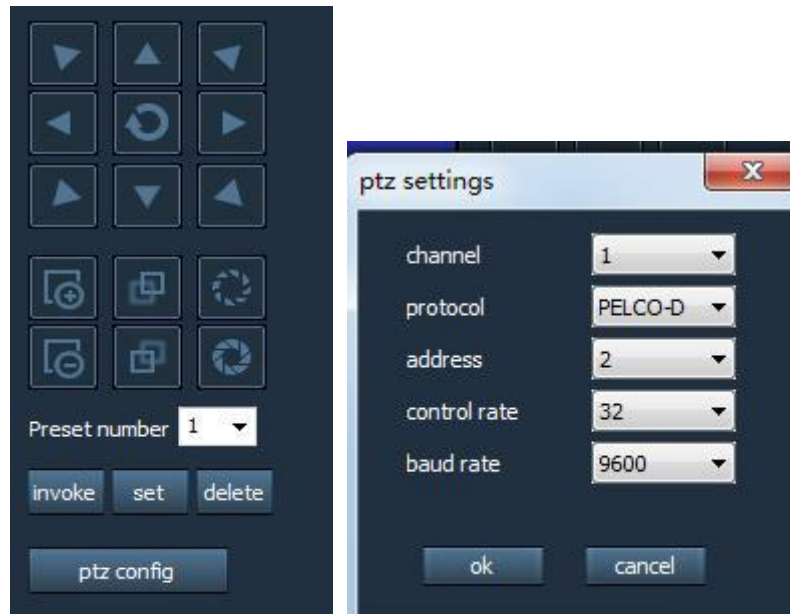

Check button “ptz config” to set channl’s ptz param. And then you can control ptz device.

Howto operation: select channel on the video view ,check ptz operation buttons to control ptz device ,result show in video.

3.3.1.3 record operation

Check button“record search”will show the UI of record operation:

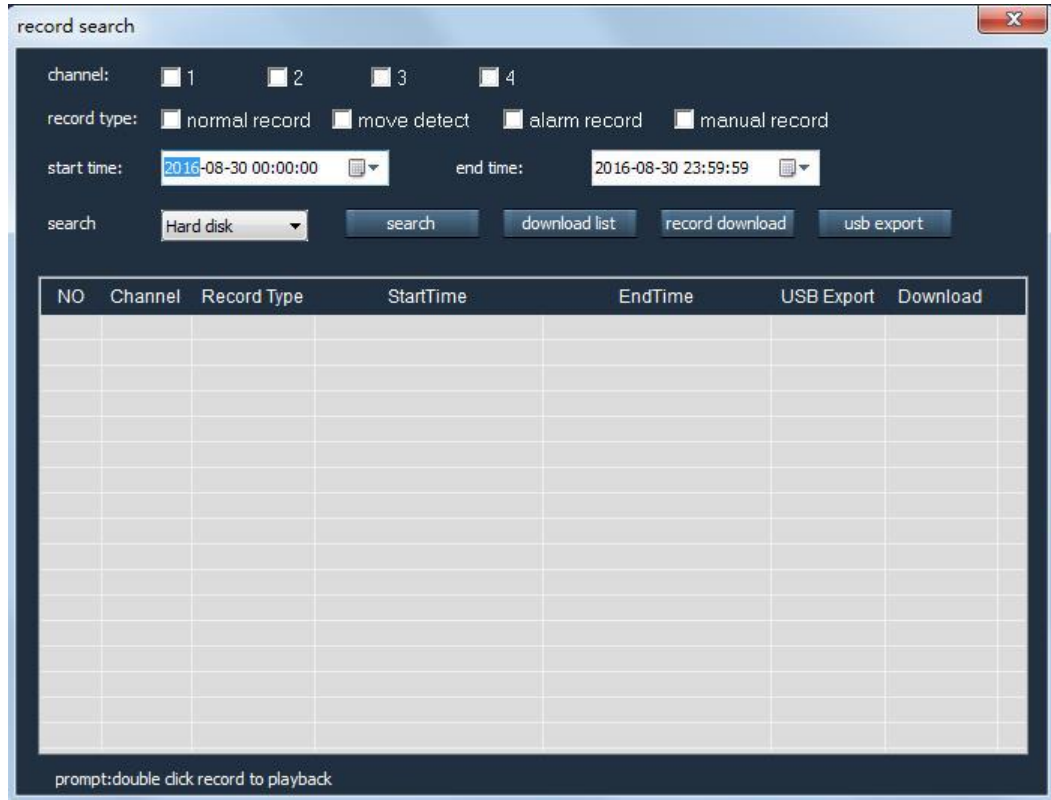

Record search:

Select channel,record type,start time,end time,storage type. The search result like below figure

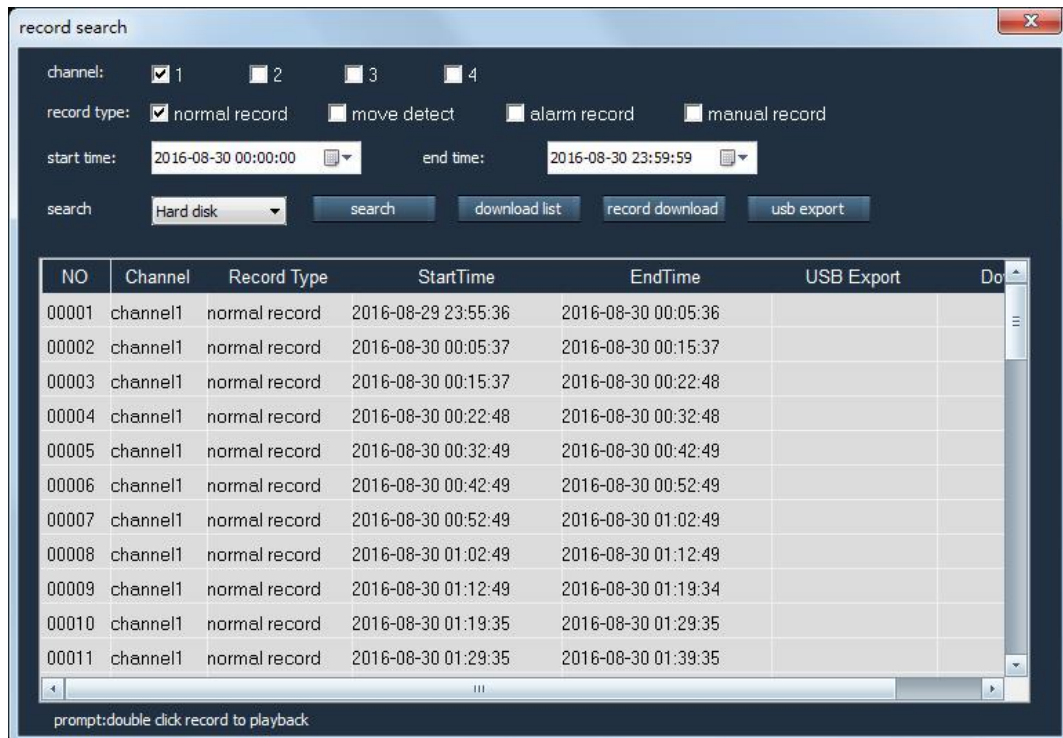

Record playback:

Double click a record item to playback,you can drag the scroll bar to control the view



Download record to computer:

select a record item and check button “record download”,download select file to local computer. Show progress in download list. multi file can be download on the same time.

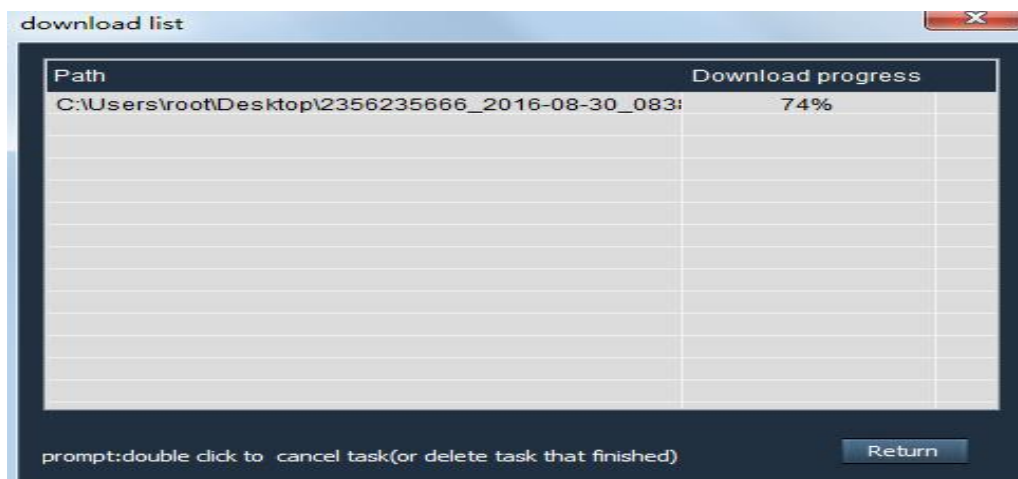

Usb storage export:

select a record item and check button “usb export”,export this record to the usb storage connected to device. Show progress in “usb export”column.export only one file on the same time.

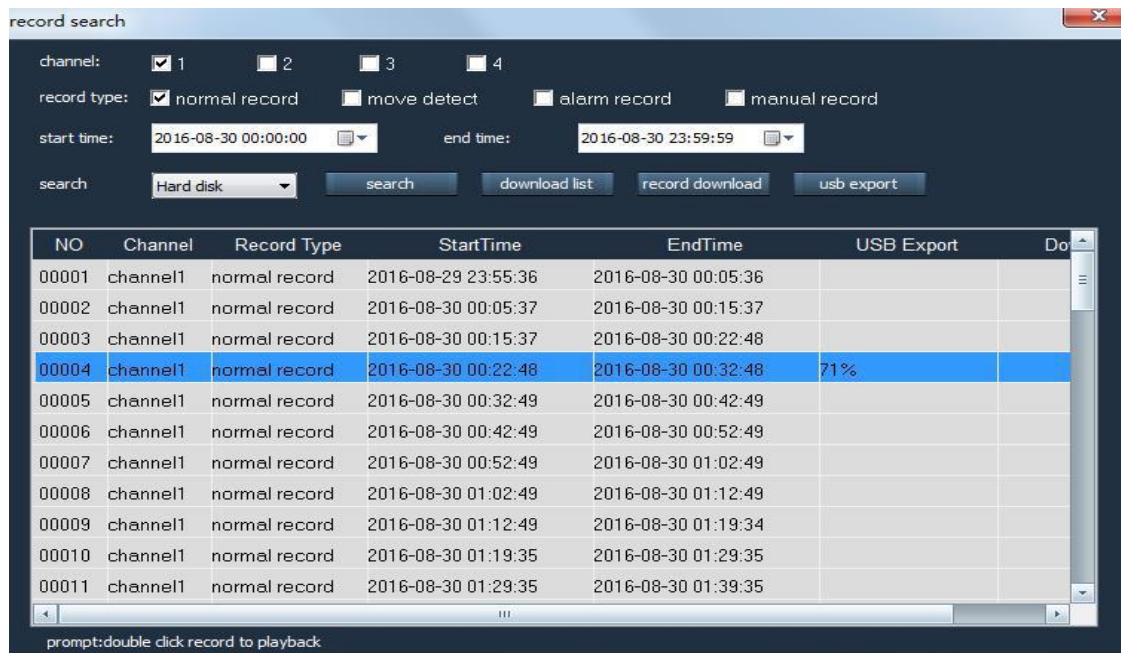

3.3.2 record task setting

Record Settings

set manual record

Manual Record 1 2 3 4

set record channel

Channel Move Detect Value od alarm switch

Record File Len minute(s) Alarm Record Time minute(s) Pre-recorded second(s)

Mode Configurable Always close

copy to channel all 1 2 3 4

	Normal	Detect	Alarm
Weekday <input type="text" value="Tuesday"/>			
<input checked="" type="checkbox"/> Period1 <input type="text" value="00"/> : <input type="text" value="00"/> : <input type="text" value="01"/> : <input type="text" value="00"/>	<input type="checkbox"/>	<input checked="" type="checkbox"/>	<input type="checkbox"/>
<input checked="" type="checkbox"/> Period2 <input type="text" value="01"/> : <input type="text" value="01"/> : <input type="text" value="01"/> : <input type="text" value="02"/>	<input checked="" type="checkbox"/>	<input type="checkbox"/>	<input type="checkbox"/>
<input checked="" type="checkbox"/> Period3 <input type="text" value="18"/> : <input type="text" value="00"/> : <input type="text" value="22"/> : <input type="text" value="59"/>	<input type="checkbox"/>	<input type="checkbox"/>	<input checked="" type="checkbox"/>
<input checked="" type="checkbox"/> Period4 <input type="text" value="12"/> : <input type="text" value="33"/> : <input type="text" value="13"/> : <input type="text" value="00"/>	<input checked="" type="checkbox"/>	<input type="checkbox"/>	<input type="checkbox"/>

Manual record:

Set the channels will record when IR control button “record”Checked.

Set record channel:

“Set record channel” include move detect value,od alarm switch,packet record file time len,alarm record time len,alarm record prerecord time len,record mode.

move detect value:

Little value can trigger the move detect alarm easier, choose suitable value or close it.

od alarm switch:

obsured detect on/off;

packet record file time len:

this param make easier for record search and playback,too long packet time len take more time to record serach and playback. too short packet time len make too much record file ,it make

hard management record.

range:10~30min.

Alarm delay record time len:

Record time len for alarm tigger.

range:1~30min.

Alarm prerecord time len:

record a few seconds before alarm tigger.

range:0~10 second

record mode:

1 close:close record anytime.

2 config: four periods for record everyday ,format is hh:mm.

3 always:alway recording.

3.3.3 system settings

3.3.3.1 general settings

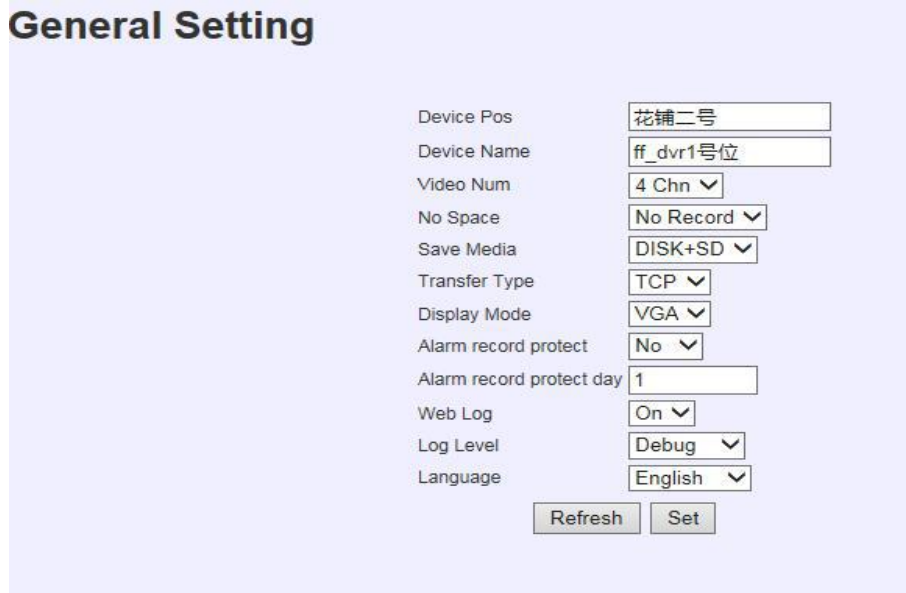

The screenshot shows a web interface titled "General Setting" with the following configuration options:

Device Pos	花铺二号
Device Name	ff_dvr1号位
Video Num	4 Chn
No Space	No Record
Save Media	DISK+SD
Transfer Type	TCP
Display Mode	VGA
Alarm record protect	No
Alarm record protect day	1
Web Log	On
Log Level	Debug
Language	English

Buttons: Refresh, Set

Device pos:

Len:0~20 character

full disk:

While disk full ,howto record:

1 stop record 2 Override

When select Override,the oldest will be Overridefirst.

Alarm record protect:

If open it,when disk full,record Override write will no Override it if it less protect day.

Alarm record protect day:

range:1~99day

Transfer Type:

Transfer protocol with video server,include RTP/UDP/TCP

Udp is based on rtp ,add packet reset if loss,it has simple rate control,has less time delay.

Tcp use tcp protocol ,it has perfect rate control.

Web Log;

Open/close web log. Web log page in System information.

3.3.3.2 code settings

Analog mode:

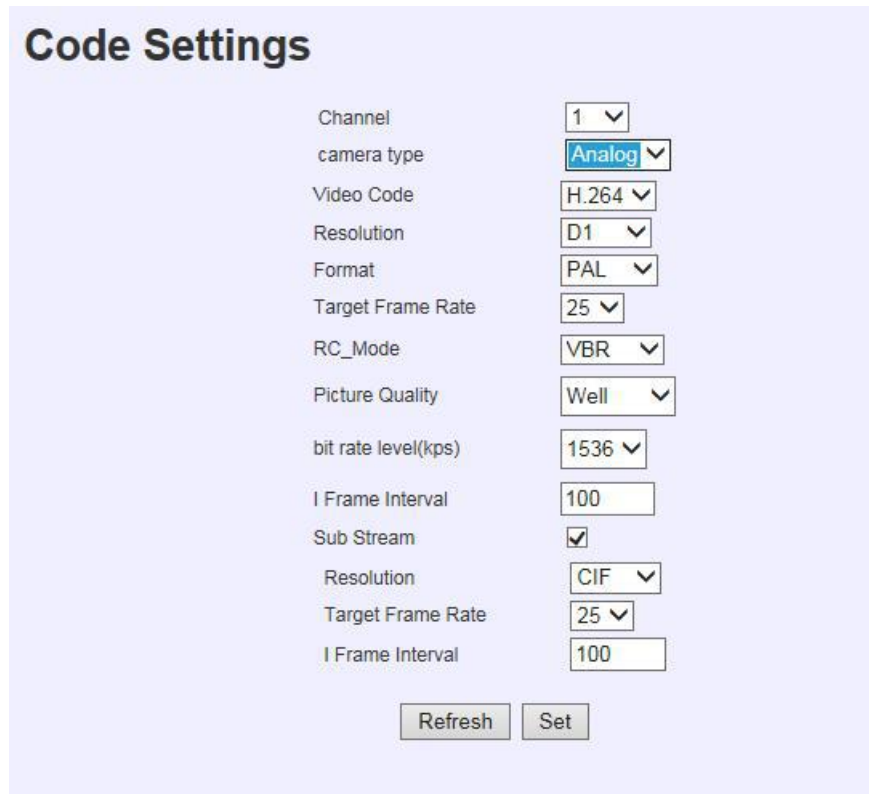

Code Settings

Channel	1
camera type	Analog
Video Code	H.264
Resolution	D1
Format	PAL
Target Frame Rate	25
RC_Mode	VBR
Picture Quality	Well
bit rate level(kps)	1536
I Frame Interval	100
Sub Stream	<input checked="" type="checkbox"/>
Resolution	CIF
Target Frame Rate	25
I Frame Interval	100

Refresh Set

resolution:

Video resolution :include D1,CIF,QCIF

D1resolution :704×576 CIF:352×288 QCIF:176×144

RC_Mode:

Rate control mode:include vbr,cbr,fixqp;

We suggest select vbr.

Pictrue quality:

Pictrue beater need bigger rate.

I frame interval:

It meas a key frame or complete frame,it can decode one complete picture,

If loss date when transfer ,video have mosaic,it need new I frame interval to revert normal video.

We suggest this value four times of video target frame rate.

Sub stream:

If open sub stream , sub stream be transfered when remote preview video .

If normal config small resolution or less target frames,to got less data rate for net transfer.

It also include resolution set,target frame rate,I frame interval:

Config suggest:

1 if need storage High quality video ,choose biggest resolution .if need High quality preview and have enouth network bandwidth close sub stream .

If narrow network bandwidth open sub stream and choose small resolution or less target frames.

2 I frame interval value choose four times of target frames.

3 rc_mode choose vbr.

Digital mode:

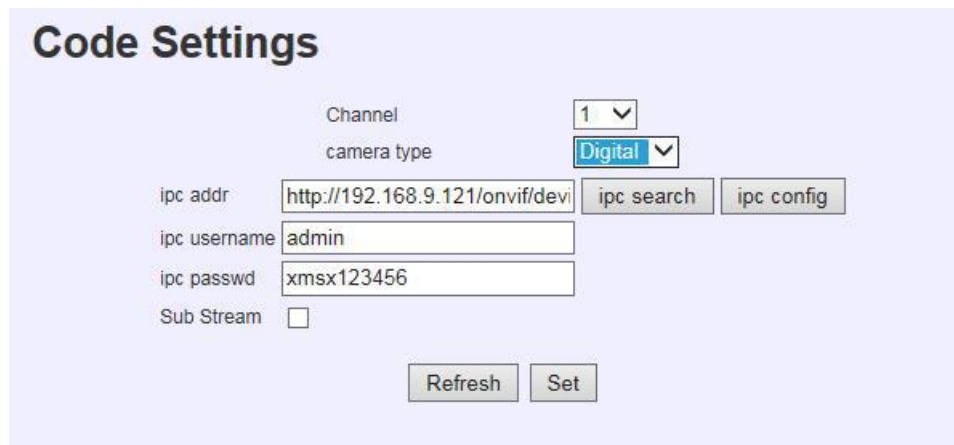

Code Settings

Channel: 1

camera type: Digital

ipc addr: http://192.168.9.121/onvif/devi

ipc username: admin

ipc passwd: xmsx123456

Sub Stream:

Buttons: ipc search, ipc config, Refresh, Set

Ipc addr :check “ipc search” button open ipclist page,ipclist page list ipc device in LAN.

Check “select” button to select ipc addr.



addr

http://192.168.9.121/onvif/device_service	select
---	--------

Buttons: refresh, select

Sub sttream:open it,bs live video will use ipc substream.

Ipc config:check “ipc config” button open the home page of ipc config web.

3.3.3.3 network settings

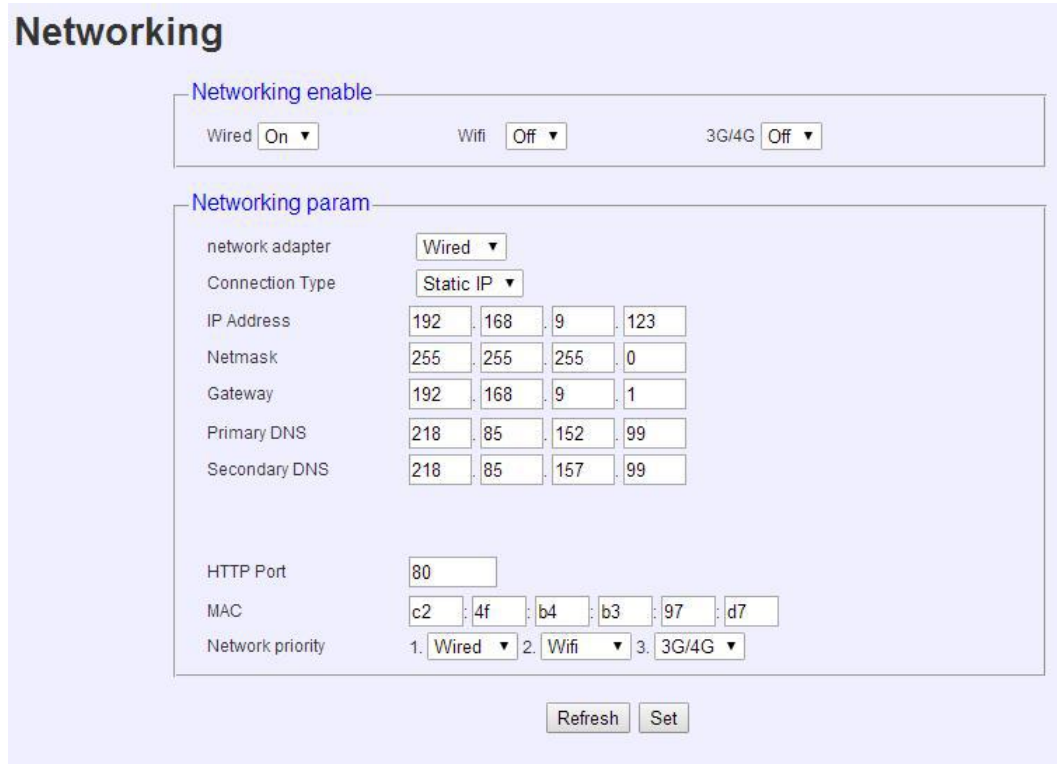

Networking enable:

Enable wired/WIFI/wireless(3G/4G) function.

Networking param:

http port:

Local web http port,if config it ,web url must be http://ip:port.

Network priority:

priority 1 is highest, device choose higher priority net to connect to Internet.

Like if “wired”priority higher than “wifi”,wifi connected to Internet,now “wired”net revert normal,it will close wifi connect,connect by“wired”net.

network adapter:

Include wired,WIFI,3G/4G

1.wired:

Connect type have static ip,dhcp

Choose “dhcp” it maybe need dhcp hostname (optionnal)



Choose "static ip" there should be config: IP, netmask, Gateway, Primary DNS, Secondary

DNS. Like below figure:

network adapter	Wired ▾			
Connection Type	Static IP ▾			
IP Address	192	168	9	123
Netmask	255	255	255	0
Gateway	192	168	9	1
Primary DNS	218	85	152	99
Secondary DNS	218	85	157	99

2.WIFI config:

Need config param:ssid,pasword,connect type.

network adapter	Wifi ▾
Connection Type	DHCP ▾
Ssid	<input type="text"/>
Password	<input type="text"/>

network adapter	Wifi ▾			
Connection Type	Static IP ▾			
Ssid	<input type="text"/>			
Password	<input type="text"/>			
IP Address	192	168	1	253
Netmask	255	255	255	0
Gateway	192	168	1	1
Primary DNS	218	85	152	99
Secondary DNS	218	85	157	99

3.3G config:

Choose “3G”,there param need config:dialing number,user name, password, APN, PIN, keeponline type, keeponline server.like below figure:

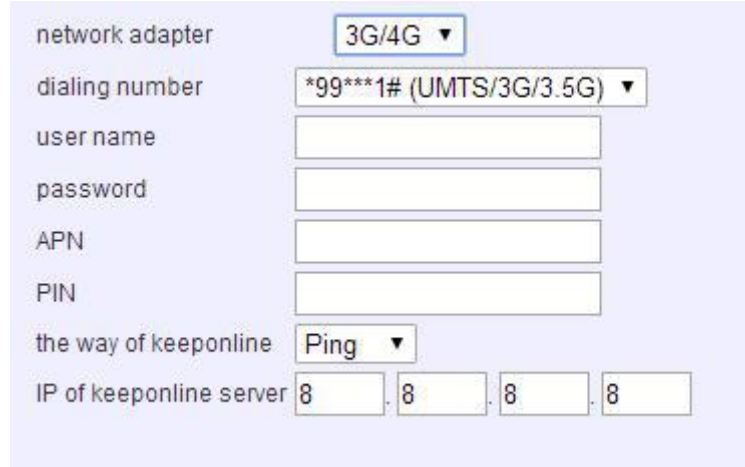

The screenshot shows a configuration window with the following fields:

- network adapter: 3G/4G (dropdown)
- dialing number: *99***1# (UMTS/3G/3.5G) (dropdown)
- user name: (text input)
- password: (text input)
- APN: (text input)
- PIN: (text input)
- the way of keeponline: Ping (dropdown)
- IP of keeponline server: 8 . 8 . 8 . 8 (four separate input boxes)

dialing number:

“*99# (UMTS/3G/4G) ”

”#777(CDMA/EVDO)”

“*99*1# (TD-SCDMA) ”

“#99***3# (LTE/3.75/4G) ”。

Username/password:

Value normal should be null or “card” 。

APN:

Value normal should be null or “card” 。

PIN:

Value normal should be null or sim card pin.

keeponline:

“none”,”ping”,”route”,。“none” close 3G/4G keeponline function, config be ”ping” or “route” will check route online status ,when offline ,it will redial.

3.3.3.4 servers

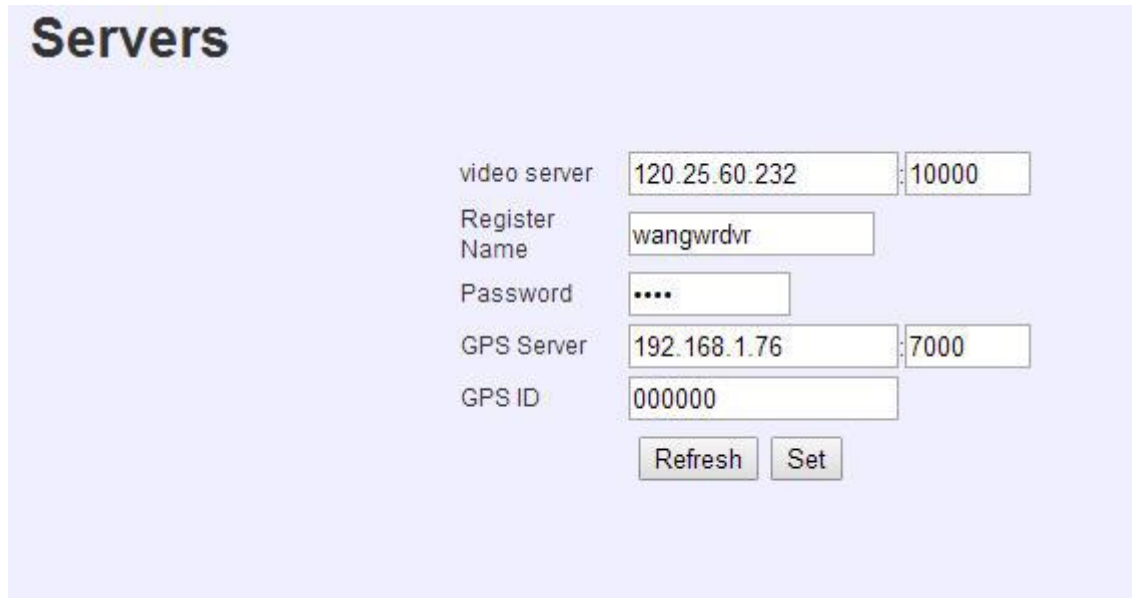

Servers

video server: 120.25.60.232 : 10000

Register Name: wangwrdrv

Password:

GPS Server: 192.168.1.76 : 7000

GPS ID: 000000

Refresh Set

Video server:

Video server addr/port.,addr could be ip or domain name.

Register name/password:

allocated by video server.

Gpsserver:

Gps server addr/port,addr could be ip or domain name.

3.3.3.5 output setting

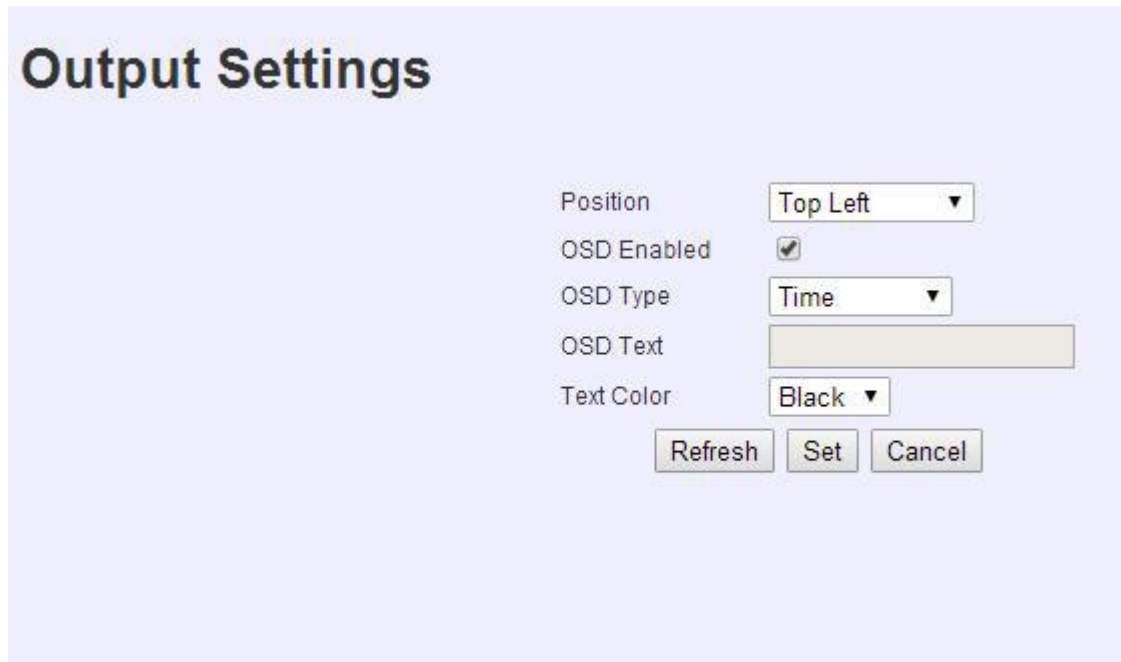

The screenshot shows the 'Output Settings' window. It contains the following fields and controls:

- Position: Top Left (dropdown menu)
- OSD Enabled:
- OSD Type: Time (dropdown menu)
- OSD Text: (text input field)
- Text Color: Black (dropdown menu)
- Buttons: Refresh, Set, Cancel

Position:

Four position can be config: top_left,top_right,bottom_left,bottom_right.

OsD enabled:

Enable or disable choose position status.

OSD type:

- 1.Time format:“yyyy-mm-dd hh:mm:ss”.
- 2.Deviceid+channleno: format: deviceid chn:1.
- 3.Device pos: value config by general settings.
- 4.GPS info: display gps information,such as longitude and latitud.
- 5.speed: display car speed value.
- 6.alarm: display alarm status if alarm tigger.
- 7.extext: limit input 20 character.

Text color:

OSD color for UI local display.

3.3.3.6 alarm set

alarm linkage config					
Alarm Type	Status	OUT1	OUT2	OUT3	
Speed High	Off ▼	No ▼	No ▼	No ▼	
Speed Low	Off ▼	No ▼	No ▼	No ▼	
IN1	Off ▼	No ▼	No ▼	No ▼	
IN2	Off ▼	No ▼	No ▼	No ▼	
IN3	Off ▼	No ▼	No ▼	No ▼	
IN4	Off ▼	No ▼	No ▼	No ▼	
IN5	Off ▼	No ▼	No ▼	No ▼	

1.Alarm linkage config:

Status : alarm enable/disable.

out1、 out2、 out3: when alarm tigger linkage digital output.

Alarm type :speed high,speed low,IN1(digital input 1),IN2,IN3,IN4,IN5.

Speed high,speed low tigger threshold config by gps server.

digital input tigger by outside device.

2.Alarm record config:

When alarm tigger,those choose channles will be recorded.

alarm record config									
Speed H Alarm Rec	<input type="checkbox"/>	<input type="checkbox"/>	<input type="checkbox"/>	<input type="checkbox"/>	<input type="checkbox"/>	<input type="checkbox"/>	<input type="checkbox"/>	<input type="checkbox"/>	<input type="checkbox"/>
Speed L Alarm Rec	<input type="checkbox"/>	<input type="checkbox"/>	<input type="checkbox"/>	<input type="checkbox"/>	<input type="checkbox"/>	<input type="checkbox"/>	<input type="checkbox"/>	<input type="checkbox"/>	<input type="checkbox"/>
In 1 Alarm Rec	<input type="checkbox"/>	<input type="checkbox"/>	<input type="checkbox"/>	<input type="checkbox"/>	<input type="checkbox"/>	<input type="checkbox"/>	<input type="checkbox"/>	<input type="checkbox"/>	<input type="checkbox"/>
In 2 Alarm Rec	<input type="checkbox"/>	<input type="checkbox"/>	<input type="checkbox"/>	<input type="checkbox"/>	<input type="checkbox"/>	<input type="checkbox"/>	<input type="checkbox"/>	<input type="checkbox"/>	<input type="checkbox"/>
In 3 Alarm Rec	<input type="checkbox"/>	<input type="checkbox"/>	<input type="checkbox"/>	<input type="checkbox"/>	<input type="checkbox"/>	<input type="checkbox"/>	<input type="checkbox"/>	<input type="checkbox"/>	<input type="checkbox"/>
In 4 Alarm Rec	<input type="checkbox"/>	<input type="checkbox"/>	<input type="checkbox"/>	<input type="checkbox"/>	<input type="checkbox"/>	<input type="checkbox"/>	<input type="checkbox"/>	<input type="checkbox"/>	<input type="checkbox"/>
In 5 Alarm Rec	<input type="checkbox"/>	<input type="checkbox"/>	<input type="checkbox"/>	<input type="checkbox"/>	<input type="checkbox"/>	<input type="checkbox"/>	<input type="checkbox"/>	<input type="checkbox"/>	<input type="checkbox"/>

3.Alarm other config:

OSD Display	No ▼	Alarm Effect Times(s)	0
Alarm Mode	Low to High ▼	Alarm Output Times(s)	0

Include osd display enable,alarm effect times(second),alarm mode,alarm output times(second).

osd display enable: enable alarm osd for ui display.

Alarm effect times: the same alarm tigger in the effect time should be ignore, different alarm or out of effect times alarm tigger should be valid.

Alarm mode: tigger mode 1 low to high 2 high to low.

Alarm output times : times for linkage digital output.

3.3.3.7datetime set

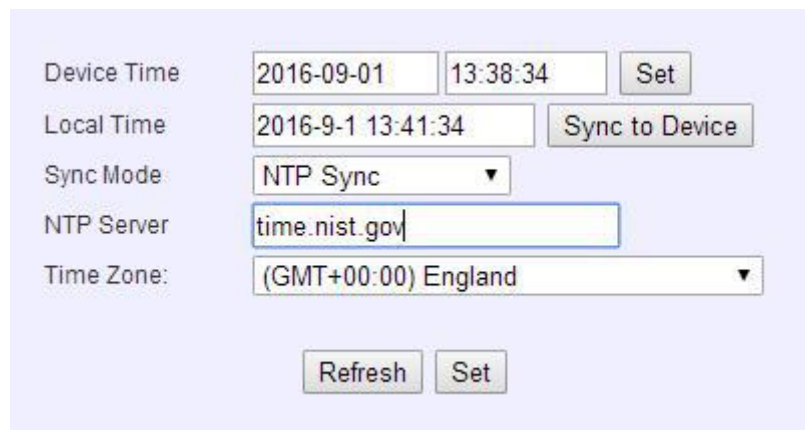

The screenshot shows a configuration interface for setting the device's datetime. It includes the following fields and controls:

- Device Time:** Two input boxes for date (2016-09-01) and time (13:38:34), followed by a "Set" button.
- Local Time:** An input box showing the local time (2016-9-1 13:41:34) and a "Sync to Device" button.
- Sync Mode:** A dropdown menu currently set to "NTP Sync".
- NTP Server:** An input box containing "time.nist.gov".
- Time Zone:** A dropdown menu currently set to "(GMT+00:00) England".
- At the bottom, there are "Refresh" and "Set" buttons.

Datetime set: set device date and time and refresh to rtc .

button “set”, manual mode.

Sync to device: sync pc date/time to device.

Sync mode: include close,gps sync,ntp sync.

gps sync,time sync with the time support by gps.

Ntp sync,time sync with the time support by ntp server.

3.3.3.8 capture

channel	1
Enable	<input checked="" type="checkbox"/>
interval time	3600
<input type="button" value="Refresh"/> <input type="button" value="Set"/>	

Interval time:capture picture ever interval time second.

3.3.3.9 gsensor setting

Enable		<input checked="" type="checkbox"/>
alarm threshold		
x axis	± 5	0 g
y axis	± 3	0 g
z axis	± 3	0 g
<input type="button" value="Refresh"/> <input type="button" value="Set"/>		

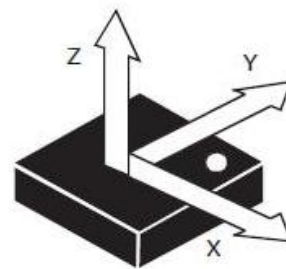

Alarm threshold:x axis,y axis,z axis,unit:g

3.3.3.10 wifi auto upload

video upload

upload addr config

upload addr :

user name

password

recent hours of record to upload

type of record to upload normal record md record alarm record manual record

Upload record when network switch wifi,

3.3.3.11 ROI setting

Channel

Enable

rect x y w h

qp

frame

state

3.3.4 system manage

3.3.4.1harddisk management

Auto get curtime disk info when the harddisk management page open,show like :

Num	Disk	Capacity
1	mmcblk0	64.4GB

Format:prealloc multi large files user for video record,is useful of protect filesystem when power lost.

notice:it is a long time for format disk ,please keep power on device when format start,wating for end of format without operat.

3.3.4.2 account

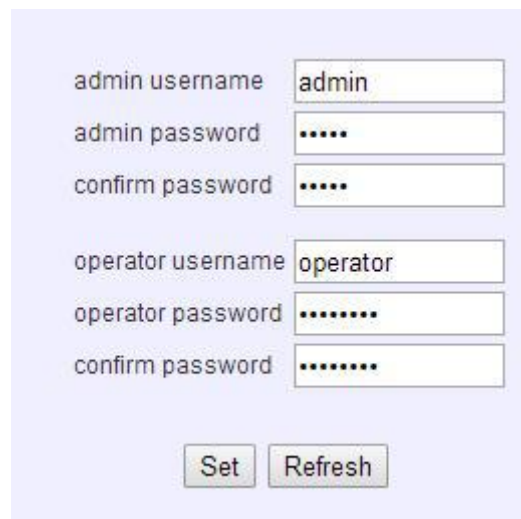

The screenshot shows a configuration page for user accounts. It contains two sets of input fields. The first set is for the administrator account, with fields for 'admin username' (containing 'admin'), 'admin password' (masked with dots), and 'confirm password' (masked with dots). The second set is for an operator account, with fields for 'operator username' (containing 'operator'), 'operator password' (masked with dots), and 'confirm password' (masked with dots). At the bottom of the form are two buttons: 'Set' and 'Refresh'.

Only administrator can access the page,operation include modify admin username/password and operator username/password for web and UI login.

3.3.4.3 Auto Maintenance

Auto reboot for keep system healthy.



The screenshot shows the 'Auto Reboot' configuration section. It features a label 'Auto Reboot' followed by a dropdown menu set to 'Every day', and two time selection fields: '00' and '06'. Below these fields are two buttons: 'Refresh' and 'Set'.

3.3.4.4 Restore Default

ALL Settings	<input type="checkbox"/>		
General Settings	<input type="checkbox"/>	Code Settings	<input type="checkbox"/>
Record Settings	<input type="checkbox"/>	Alarm Settings	<input type="checkbox"/>
Networking Settings	<input type="checkbox"/>	NetServer Settings	<input type="checkbox"/>
Account Settings	<input type="checkbox"/>	Ptz Settings	<input type="checkbox"/>
Output Settings	<input type="checkbox"/>	Datetime Settings	<input type="checkbox"/>
Bootmode Settings	<input type="checkbox"/>		
<input type="button" value="OK"/>			

3.3.4.5 Firmware Upgrade

Z:\F6934_STD-APP-v1.0	<input type="button" value="Browse..."/>	<input type="button" value="upgrade"/>
-----------------------	--	--

Check the “Browser” button,select the upgrade file ,check “upgrade” button to upgrade the device firmware.

notice:it is a long time for upgrade ,please keep power on device when upgrade start,wating for end of upgrade without operat.

3.3.4.6 bootmode setting

- Param include:
1. acc delay poserooff (only for vehicle device)
 2. Adc lower poweroff (only for vehicle device)
 3. Boot mode (ever,acc ,timer,acc+timer)

ACC Delay PowerOff(sec)	<input type="text" value="20"/>
ADC Lower PowerOff (sec)	<input type="text" value="3"/>
Boot Mode	<input type="text" value="Ever"/>
	<input type="button" value="Refresh"/> <input type="button" value="Set"/>

acc delay poweroff (sec):

system power off after the preset seconds if acc close When bootmode is ever or acc+time mode.

adc lower poweroff(set):

system power off after the preset seconds if under-voltage . It can protect the device ,stop device reboot again and again when under-voltage .

System recovery power on if voltage up to normal value (if device in the boot time period).

Boot mode

1) Ever

Only Infrared remote controller can power-on-and-off the device.

2) Acc

In this mode:acc and Infrared remote controller power-on-and-off the device.

(1) Device power on when acc on.

(2) Device power off when acc off

(3) Ir control device power on when device power off state.off acc can shutdown device when device power on by ir .

(4) Ir control device power off when device power on state.up acc can power on device when device shutdown by ir.

3) Timer

In this mode,ir can power-on-and-off the device.

- (1) device shutdown when curtime out of boot time segments.
- (2) device power on when curtime in boot time segments.
- (3) device shutdown next out of boot time segments when device power on by ir .
- (4) device power next in boot time segments when device shutdown by ir .

4) Acc+timer

In this mode: Infrared remote controller power-on-and-off the device

- (1) Power on device when acc on or curtime in boot time segments.
- (2) shutdown device when acc off and curtime out of boot time segments.
- (3) device shutdown next out of boot time segments and acc off when device power on by ir .
- (4) power on device next boot time segments (or acc up from off state) when device shutdown by ir.

3.3.4.7 reboot

Reboot DVR device.

3.3.4.8 cmddebug

For debug,operat by technician for manufacturer .



3.3.5 system information

3.3.5.1 system status

3g/4g net status

interface	connect status	signal strength	signal quality	module	sim
3G/4G	haven't dial	0dbm	0%	no module	not exist

wifi status

interface	connect status	signal strength	signal quality
WIFI	wifi not connected	0dbm	0%

gps status

hardware	antenna	location	moon number	longitude	latitude
not exist	not connect	not positioned	0	0.0	0.0

store status

store device	capacity	used	health status
hard disk	0MB	0MB	not exist
sd card	64000MB	44288MB	OK

record status

channel no	record status
channel1	normal record
channel2	normal record
channel3	normal record
channel4	normal record
channel5	normal record
channel6	normal record
channel7	normal record
channel8	normal record

system running time

13:52:28 up 19:55, load average: 10.80, 11.06, 11.09

Refresh

System status include 3g/4g net status ,wifi status ,gps status,store status,record status ,running time of device.

3.3.5.2 version

Include roots version,app version,mcu software version.

Software	Software Version
roots version:	F6934_STD-FS-v1.0-20160831-152339
app version:	F6934_STD-APP-v1.0-20160831-152339
MCU Software Version:	F693x_STD_MCU-v1.0-20160831

3.3.5.3 device log

log into

```

hi_dvr debug::FILE: src/common/http_proto.c, FUN :ff_pic_upload_thread LINE: 1148: check resend
jpg,chn:0,filenum:0,upindex:0

hi_dvr debug::FILE: src/dvr/signalcontrol.c, FUN :control_findcmd LINE: 2016:
 protonum = ffff body =<?xml version="1.0" encoding="utf-8"?><Message><IE_HEADER
 MessageType="KEEPALIVE_ACK" MessageDir="CONTROL_TO_TERMINAL" /><IE_BODY result="0" /></Message>

hi_dvr debug::FILE: src/common/http_proto.c, FUN :ff_pic_upload_thread LINE: 948: checking i=0
now.tv_sec=1472737624,pretime.tv_sec=1472734702,tag:1,gap:3600

hi_dvr debug::FILE: src/common/http_proto.c, FUN :ff_pic_upload_thread LINE: 1148: check resend
jpg,chn:0,filenum:0,upindex:0

hi_dvr debug::FILE: src/common/http_proto.c, FUN :ff_pic_upload_thread LINE: 948: checking i=0
now.tv_sec=1472737629,pretime.tv_sec=1472734702,tag:1,gap:3600

hi_dvr debug::FILE: src/common/http_proto.c, FUN :ff_pic_upload_thread LINE: 1148: check resend
jpg,chn:0,filenum:0,upindex:0

hi_dvr debug::FILE: mcu/mcu_interface.c, FUN :beatDo LINE: 1273: beatDo=====

hi_dvr debug::FILE: mcu/mcu_interface.c, FUN :send_command LINE: 296: rcv:OK

hi_dvr debug::FILE: src/common/http_proto.c, FUN :ff_pic_upload_thread LINE: 948: checking i=0
now.tv_sec=1472737634,pretime.tv_sec=1472734702,tag:1,gap:3600

hi_dvr debug::FILE: src/common/http_proto.c, FUN :ff_pic_upload_thread LINE: 1148: check resend

```

Chapter4 UI config param

The UI parameter is basically the same as the web parameter , does not introduce the meaning of each parameter one by one, detailed reference the web parameter .

4.1 system setting

UI man page:



4.1.1 login

Check ir control button “login” into UI parameter page. If you are on login ,UI turn to login

page:



User/passwd is admin Factory default set.you can change them.

Software keypad usage:the software keypad show when the cursor into editbox,use ir control key “left”,”right”,”up”,”down” select character ,check ir control key “enter” input the character to editbox,check ir control “back” close software keypad.

4.1.2 record setting



Ir_record: check ir control key “rec” start or stop ir record .

4.1.3 record search

Check Ir control key “↑”,“↓” switch ui controls,when cursor on search result editbox,check ir control key “edit+” ,“edit-” select record file,check “enter” to replay selected record:

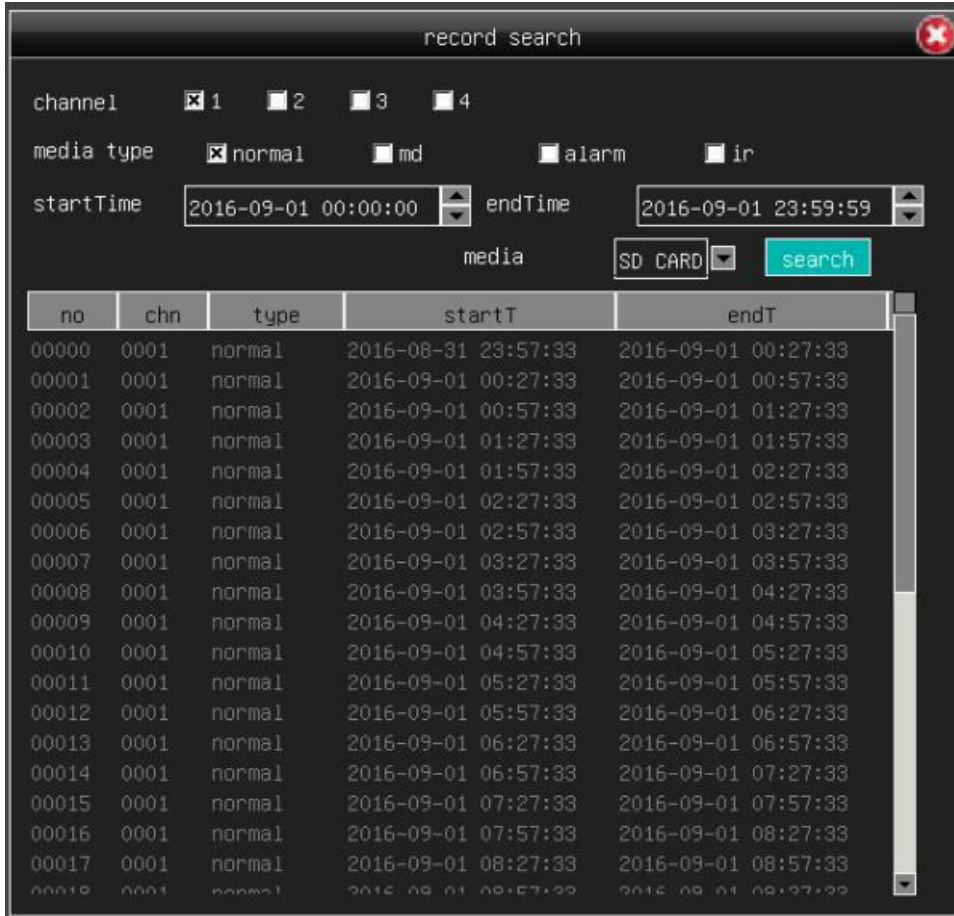

Use ir controller key “play”, “forward”, “rewound”, “frameplay” control video replay .

Key “prev”, “next” switch record video.

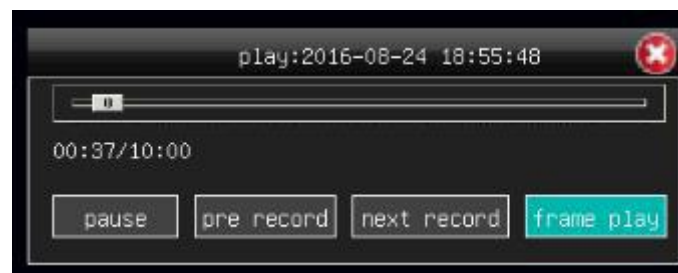

4.1.4 encode setting

Param reference web param:

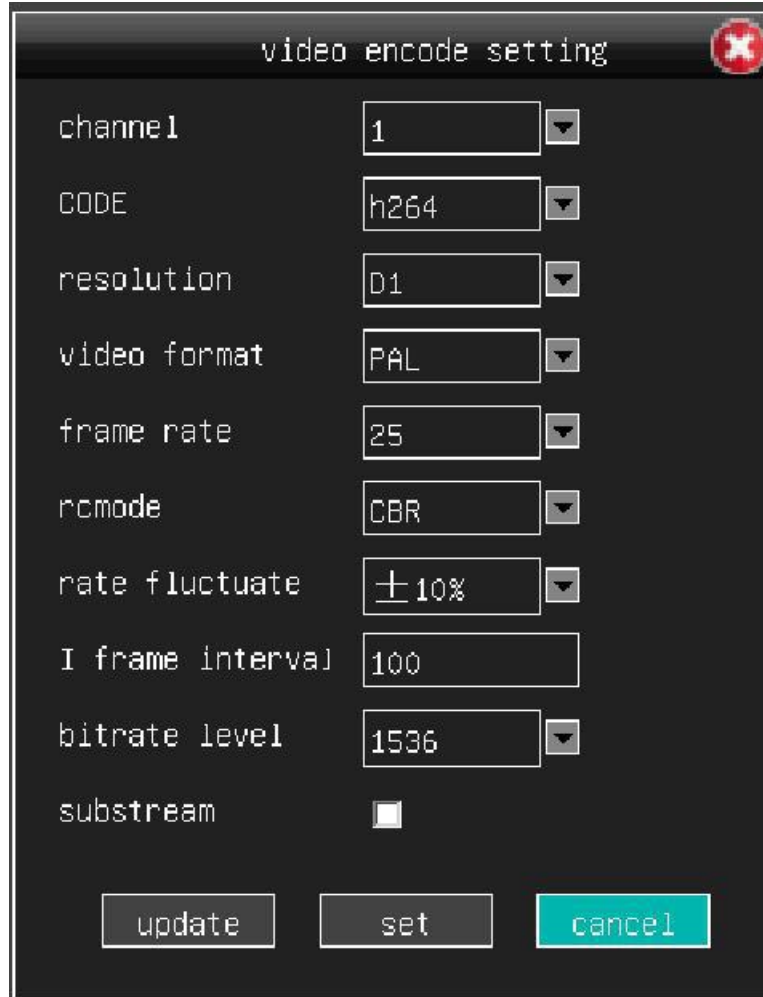

video encode setting	
channel	1
CODE	h264
resolution	D1
video format	PAL
frame rate	25
rcmode	CBR
rate fluctuate	±10%
I frame interval	100
bitrate level	1536
substream	<input type="checkbox"/>

update set cancel

4.1.5 network setting

Param reference web param:



The screenshot shows a web interface titled "network setting" with a red close button in the top right corner. The interface is divided into two sections by a dashed line. The top section contains three dropdown menus: "LAN" set to "OPEN", "WIFI:" set to "CLOSE", and "3G/4G:" set to "CLOSE". The bottom section contains several input fields and dropdown menus: "net" (3G/4G), "dial center" (#99***3# (LTE/3.75)), "user" (card), "passwd" (****), "APN" (empty), "PIN" (empty), "keepalive" (None), "keepalive server" (8.8.8.8), "http port" (80), "MAC:" (50:22:33:55:66:7), and "net priority" (1. LAN, 2. Wifi, 3. 3G/4G). At the bottom are three buttons: "update", "set", and "cancel".

4.1.6 server setting

Param reference web param:

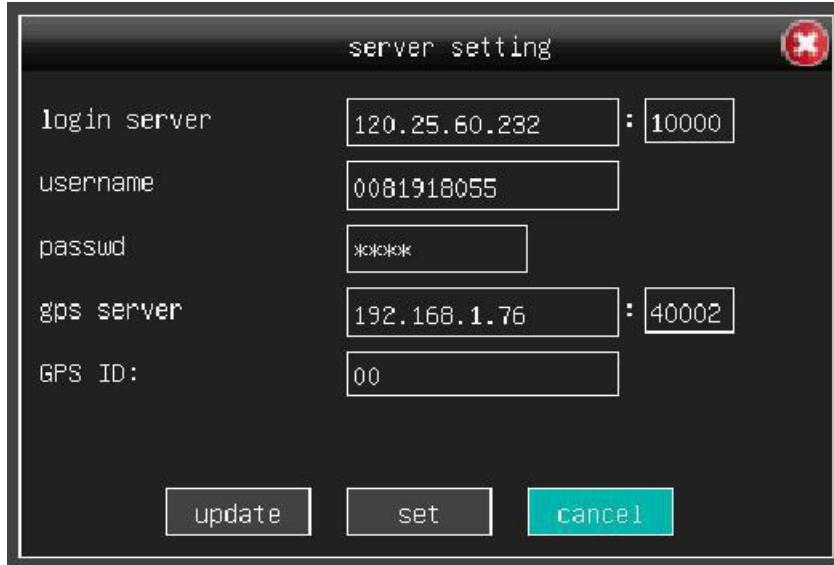

login server	120.25.60.232	:	10000
username	0081918055		
passwd	*****		
gps server	192.168.1.76	:	40002
GPS ID:	00		

update set cancel

4.1.7 OSD setting

Param reference web param:

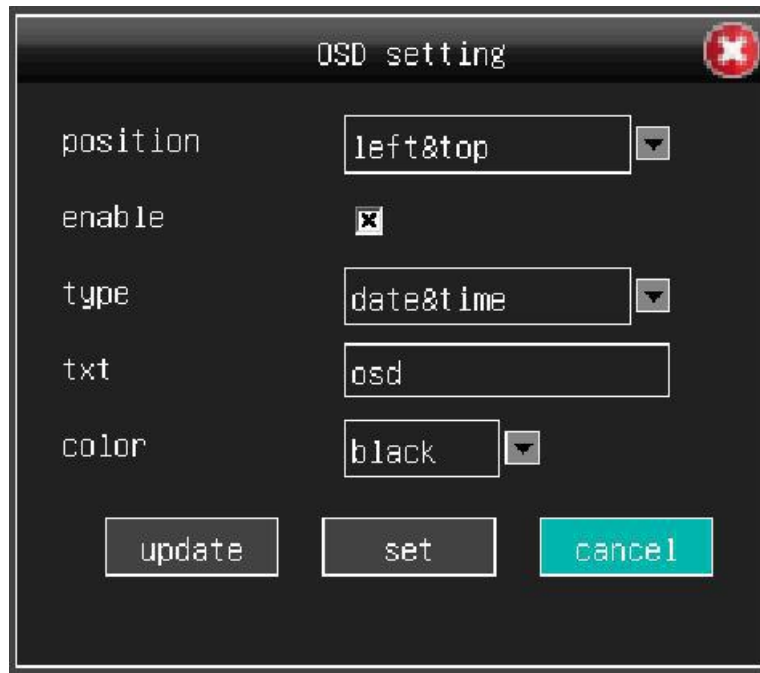

position	left&top	▼
enable	<input checked="" type="checkbox"/>	
type	date&time	▼
txt	osd	
color	black	▼

update set cancel

4.1.8 date setting

Param reference web param:

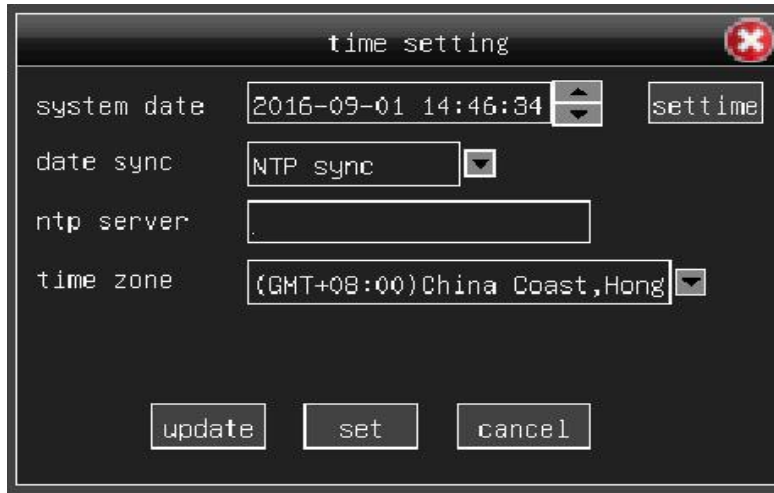

time setting

system date 2016-09-01 14:46:34 settime

date sync NTP sync

ntp server

time zone (GMT+08:00)China Coast,Hong

update set cancel

4.1.9 ptz setting

Param reference web param:

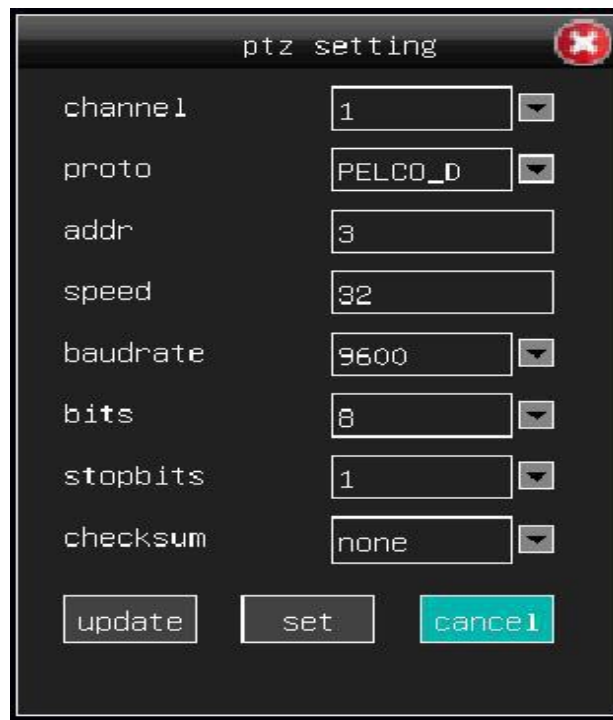

ptz setting

channel 1

proto PELCO_D

addr 3

speed 32

baudrate 9600

bits 8

stopbits 1

checksum none

update set cancel

4.1.10 capture setting

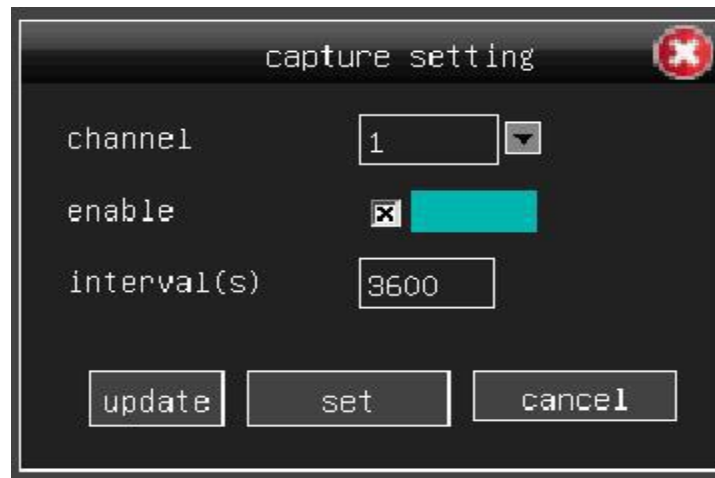

channel	1
enable	<input checked="" type="checkbox"/>
interval(s)	3600

update set cancel

4.2 system manage

4.2.1 general setting

Param reference web param:



position	NONUM
device name	ff_dvr
dvr channels	4CHN
disk full	stop re
store media	SD
transfer type	TCP
ui output	VGA
record protect	no
protect day	1

update set cancel

4.2.2 self maintaine

Operat reference web param:



self reboot

auto reboot everyday 16:20

update set cancel

4.2.3 account

Operat reference web param:

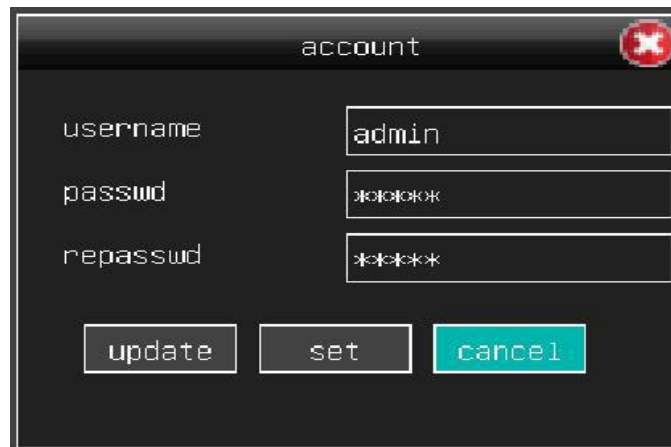

account

username admin

passwd *****

repasswd *****

update set cancel

4.2.4disk manage

Operat reference web param:

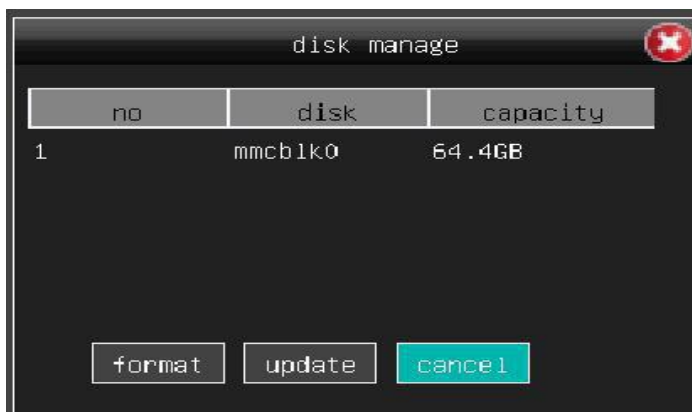

disk manage

no	disk	capacity
1	mmcblk0	64.4GB

format update cancel

4.2.5 restore

Operat reference web param:



4.2.6 record export

After record search ,check key “enter” to export video to usb storge

4.2.7 bootmode setting

Param reference web param:

bootmode setting ✖

ACC delay poweroff

lowpower delay poweroff

bootmode ▼

weekday ▼

period1 -

period2 -

period3 -

period4 -

4.2.8 reboot

Device reboot operat.

4.2.9 alarm setting

Param reference web param:

alarm setting ✖

alarm type	status	OUT1	OUT2	OUT3	record
fastspeed	<input type="text" value="close"/> ▼	<input type="text" value="no"/> ▼	<input type="text" value="no"/> ▼	<input type="text" value="no"/> ▼	<input type="text" value="channel1"/>
lowerspeed	<input type="text" value="close"/> ▼	<input type="text" value="no"/> ▼	<input type="text" value="no"/> ▼	<input type="text" value="no"/> ▼	
io input1	<input type="text" value="open"/> ▼	<input type="text" value="yes"/> ▼	<input type="text" value="no"/> ▼	<input type="text" value="no"/> ▼	
io input2	<input type="text" value="open"/> ▼	<input type="text" value="no"/> ▼	<input type="text" value="yes"/> ▼	<input type="text" value="no"/> ▼	
io input3	<input type="text" value="open"/> ▼	<input type="text" value="yes"/> ▼	<input type="text" value="no"/> ▼	<input type="text" value="yes"/> ▼	
io input4	<input type="text" value="open"/> ▼	<input type="text" value="no"/> ▼	<input type="text" value="no"/> ▼	<input type="text" value="no"/> ▼	
io input5	<input type="text" value="open"/> ▼	<input type="text" value="yes"/> ▼	<input type="text" value="no"/> ▼	<input type="text" value="no"/> ▼	

QSD display ▼ alarm valid time

trigger type ▼ alarm output time

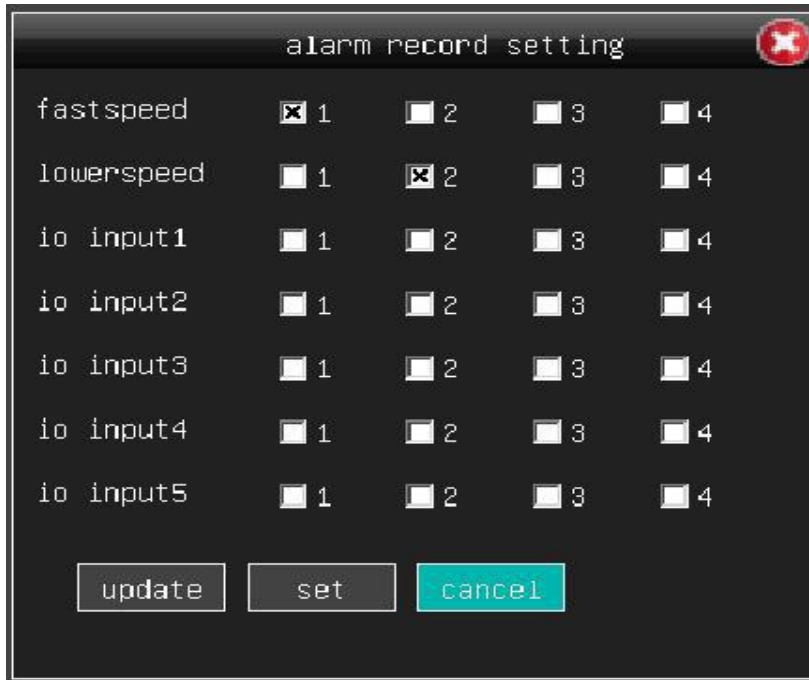

4.2.10 version

