

F3X36 Series Router User Manual	Documentation No.	Product Version	Page
		V1.00	
	Product Name:F3X36		Total:83

F3X36 Series Router User Manual

The user manual is suitable for the following model:

Model	Product Type
F3436	WCDMA WIFI ROUTER
F3736	LTE&TD-SCDMA WIFI ROUTER
F3836	LTE&WCDMA WIFI ROUTER
F3A36	LTE&EVDO WIFI ROUTER



Four-Faith Smart Power Technology Co., Ltd.

Add: Floor 11, Area A06, No 370, chengyi street, Jimei, Xiamen, China

Zip Code:361021

Tel: +86-17750019379

Email: business@four-faith.com

<http://www.four-faith.hk>



Files Revised Record

Date	Version	Remark	Author
2014-8-8	V1.00	Initial version	ZBQ/WT

Copyright Notice

All contents in the files are protected by copyright law, and all copyrights are reserved by Xiamen Four-Faith Communication Technology Co., Ltd. Without written permission, all commercial use of the files from Four-Faith are forbidden, such as copy, distribute, reproduce the files, etc., but non-commercial purpose, downloaded or printed by individual (all files shall be not revised, and the copyright and other proprietorship notice shall be reserved) are welcome.

Trademark Notice

Four-Faith、四信、、、 are all registered trademarks of Xiamen Four-Faith Communication Technology Co., Ltd., illegal use of the name of Four-Faith, trademarks and other marks of Four-Faith is forbidden, unless written permission is authorized in advance.



Contents

Chapter 1 Brief Introduction of Product.....	7
1.1 General.....	7
1.2 Features and Benefits.....	7
1.3 Working Principle.....	9
1.4 Specifications.....	9
Chapter 2 Installation Introduction.....	13
2.1 General.....	13
2.2 Encasement List.....	13
2.3 Installation and Cable Connection.....	13
2.4 Power.....	15
2.5 Indicator Lights Introduction.....	15
2.6 Reset Button Introduction.....	16
Chapter 3 Configuration and Management.....	16
3.1 Configuration Connection.....	16
3.2 Access the Configuration Web Page.....	17
3.3 Management and configuration.....	18
3.3.1 Setting.....	18
3.3.1.1 Basic Setting.....	18
3.3.1.2 Dynamic DNS.....	25
3.3.1.3 Clone MAC Address.....	26
3.3.1.4 Advanced Router.....	27
3.3.1.5 VLANs.....	29
3.3.1.6 Networking.....	29
3.3.2 Wireless.....	32
3.3.2.1 Basic Settings.....	32
3.3.2.2 Wireless Security.....	34
3.3.2.3 Wireless MAC Filter.....	36
3.3.2.4 Advance Settings.....	37
3.3.2.5 WDS.....	41
3.3.3 Services.....	43
3.3.3.1 Services.....	43
3.3.4 VPN.....	46
3.3.4.1 PPTP.....	46
3.3.4.2 L2TP.....	47
3.3.5 Security.....	48
3.3.5.1 Firewall.....	48
3.3.5.2 VPN Passthrough.....	51
3.3.6 Access Restrictions.....	52
3.3.6.1 WAN Access.....	52
3.3.6.2 URL Filter.....	54
3.3.6.3 Packet Filter.....	55
3.3.7 NAT.....	56

3.3.7.1 Port Forwarding.....	56
3.3.7.2 Port Range Forward.....	57
3.3.7.3 DMZ.....	57
3.3.8 QoS Setting.....	58
3.3.8.1 Basic.....	58
3.3.8.2 Classify.....	59
3.3.9 Applications.....	60
3.3.9.1 Serial Applications.....	60
3.3.10 Administration.....	61
3.3.10.1 Management.....	61
3.3.10.2 Keep Alive.....	63
3.3.10.3 Commands.....	64
3.3.10.4 Factory Defaults.....	65
3.3.10.5 Firmware Upgrade.....	65
3.3.10.6 Backup.....	66
3.3.11 Status.....	66
3.3.11.1 Router.....	66
3.3.11.2 WAN.....	68
3.3.11.3 LAN.....	71
3.3.11.4 Wireless.....	73
3.3.11.5 Bandwidth.....	75
3.3.11.6 Sys-Info.....	76
Appendix.....	79

Chapter 1 Brief Introduction of Product

1.1 General

F3X36 series ROUTER is a kind of cellular terminal device that provides data transfer function by public cellular network.

It adopts high-powered industrial 32-bits CPU and embedded real time operating system. It supports RS232 (or RS485/RS422), Ethernet and WIFI port that can conveniently and transparently connect one device to a cellular network, allowing you to connect to your existing serial, Ethernet and WIFI devices with only basic configuration.

It has been widely used on M2M fields, such as intelligent transportation, smart grid, industrial automation, telemetry, finance, POS, water supply, environment protection, post, weather, and so on.

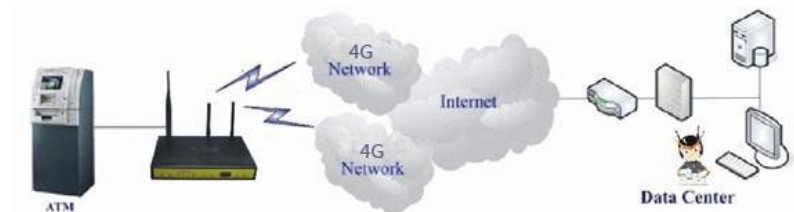

1.2 Features and Benefits

Design for Industrial Application

- ◆ High-powered industrial cellular module
- ◆ High-powered industrial 32bits CPU
- ◆ Support low-consumption mode, including sleep mode, scheduled online/offline mode, scheduled power-on/power-off mode(optional)
- ◆ Housing: iron, providing IP30 protection.
- ◆ Power range: DC 5~36V

Stability and Reliability

- ◆ Support hardware and software WDT
- ◆ Support auto recovery mechanism, including online detect, auto redial when offline to make router always online
- ◆ Ethernet port: 1.5KV magnetic isolation protection
- ◆ RS232/RS485/RS422 port: 15KV ESD protection
- ◆ SIM/UIM port: 15KV ESD protection
- ◆ Power port: reverse-voltage and overvoltage protection
- ◆ Antenna port: lightning protection(optional)

Standard and Convenience

- ◆ Support standard RS232(or RS485/RS422), Ethernet and WIFI port that can connect to serial, Ethernet and WIFI devices directly
- ◆ Support standard WAN port and PPPOE protocol that can connect to ADSL directly
- ◆ Support intellectual mode, enter into communication state automatically when powered
- ◆ Provide management software for remote management
- ◆ Support several work modes
- ◆ Convenient configuration and maintenance interface (WEB or CLI)

High-performance

- ◆ Support multiple WAN access methods, including static ip, DHCP, L2TP, PPTP,PPPOE,3G/HSPA/4G.
- ◆ Support double link backup between cellular and WAN(PPPOE, ADSL) (optional)
- ◆ Support VPN client(PPTP, L2TP, OPENVPN, IPSEC and GRE)(only for VPN version)
- ◆ Support VPN server(PPTP, L2TP, OPENVPN, IPSEC and GRE)(only for VPN version)
- ◆ Support local and remote firmware upgrade,import and export configure file.
- ◆ Support NTP, RTC embedded.
- ◆ Support multiple DDNS provider service.
- ◆ Support VLANs, MAC Address clone, PPPoE Server
- ◆ WIFI support 802.11b/g/n. support AP, client, Adhoc, Repeater, Repeater Bridge and WDS(optional) mode.
- ◆ WIFI support WEP,WPA,WPA2 encryption,Support RADIUS authentication and MAC address filter.
- ◆ Support multi online trigger ways, including SMS, ring and data. Support link disconnection when timeout
- ◆ Support APN/VPDN
- ◆ Support DHCP server and client, firewall, NAT, DMZ host , URL block, QoS, ttraff,statistics, real time link speed statistics etc.
- ◆ Full protocol support , such as TCP/IP, UDP, ICMP, SMTP(optional), HTTP, POP3(optional), OICQ(optional), TELNET, FTP(optional), SNMP, SSHD, etc.
- ◆ Schedule Reboot, Schedule Online and Offline,etc.

1.3 Working Principle

The principle chart of the router is as following:

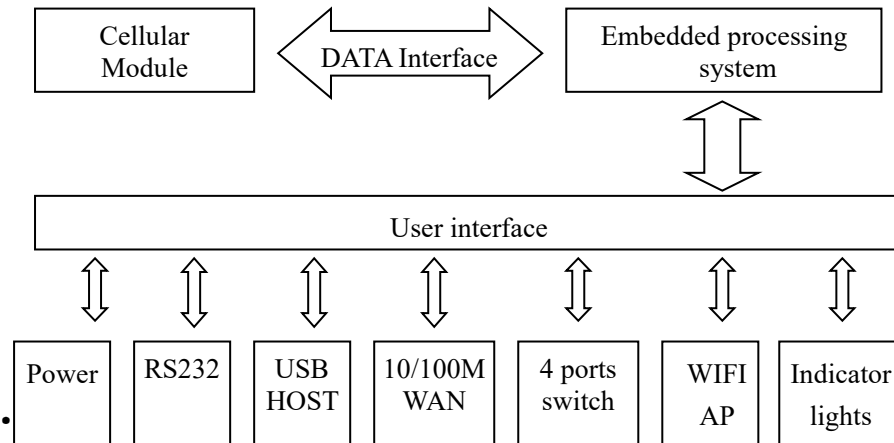

1.4 Specifications

Cellular Specification

Standard and Band	Bandwidth	TX power	RX sensitivity
F3436 WCDMA&HSDPA&HSUPA WIFI ROUTER			
UMTS/WCDMA/HSDPA/HSUPA /HSPA+ 850/1900/2100MHz 850/900/1900/2100MHz(option al) GSM850/900/1800/1900MHz GPRS/EDGE CLASS 12	HSUPA:5.76Mbps (Upload speed) HSDPA:7.2Mbps (Download speed) UMTS:384Kbps (DL/UL) HSPA+: 21 Mbps (Download speed) 5.76Mbps (Upload speed)	<24dBm	<-109dBm
F3736 LTE/TD-SCDMA+WIFI ROUTER			

<p>LTE TDD 2600/1900/2300MHz (Band 38/39/40) 800/1400/1800MHz(Band27/61/62) (optional) TD-SCDMA 2010/1900MHz (A/F frequency band, Band 34/39) GSM/GPRS/EDGE 900/1800/1900MHz</p>	<p>LTE TDD(Download speed:68Mbps , upload speed:17Mbps) /TD-SCDMA :2.2 Mbps(upload speed)/2.8Mbps(download speed)</p>	<p><23dBm</p>	<p><-97dBm</p>
F3836 LTE/WCDMA+WIFI ROUTER			
<p>LTE FDD 2600/2100/1800/900/800MHz (Band 1/3/7/8/20) 700/850/1700/1900/2100MHz (Band 2/4/5/13/17/25)(optional) DC-HSPA+/HSPA+/HSDPA/ HSUPA/WCDMA/UMTS 2100/1900/900/850/800MHz (Band 1/2/5/6/8) EDGE/GPRS/GSM 850/900/1800/1900MHz</p>	<p>LTE FDD(Download speed:100Mbps, upload speed:50Mbps) /HSUPA:5.76Mbps(upload speed)/ HSDPA:7.2Mbps(download speed:) UMTS:384Kbps (download speed/upload speed) HSPA+: 42Mbps(download speed) 5.76Mbps(upload speed)</p>	<p><23dBm</p>	<p><-93.3dBm</p>
F3A36 LTE&EVDO+WIFI ROUTER			
<p>LTE FDD 700/850/1700/1900/2100MHz (Band 2/4/5/13/17/25) CDMA 1XRTT/EVDO 800/1900MHz (Band Class 0/Class 1/Class 10)</p>	<p>LTE(Download speed:100Mbps, upload speed:50Mbps) CDMA2000 1X EVDO Rev A (download speed:3.1Mbps , upload speed:1.8Mbps)</p>	<p><23dBm</p>	<p><-93.3dBm</p>

WIFI Specification

Item	Content
Standard	IEEE802.11b/g/n
Bandwidth	IEEE802.11b/g: 54Mbps (max) IEEE802.11n: 150Mbps (max)
Security	WEP, WPA, WPA2, etc. WPS (optional)
TX power	20dBm (11n), 24dBm (11g), 26dBm (11b)
RX sensitivity	<-72dBm@54Mbps

Hardware System

Item	Content
CPU	Industrial 32bits CPU
FLASH	16MB(Extendable to 64MB)
DDR2	128MB

Interface Type

Item	Content
WAN	1 10/100 Mbps WAN port(RJ45), auto MDI/MDIX, 1.5KV magnetic isolation protection
LAN	4 10/100 Mbps Ethernet ports(RJ45), auto MDI/MDIX, 1.5KV magnetic isolation protection
Serial	1 RS232(or RS485/RS422) port, 15KV ESD protection Data bits: 5, 6, 7, 8 Stop bits: 1, 1.5(optional), 2 Parity: none, even, odd, space(optional), mark(optional) Baud rate: 2400~115200 bps
Indicator	"Power", "System", "Online", "Alarm", "Local Network", "WAN", "WIFI", "Signal Strength"
Antenna	Cellular: 2 Standard SMA female interface, 50 ohm, lightning protection(optional) WIFI: 1 Standard SMA male interface, 50 ohm, lightning protection(optional)
SIM/UIM	Standard 3V/1.8V user card interface, 15KV ESD protection
Power	Standard 3-PIN power jack, reverse-voltage and overvoltage protection
Reset	Restore the router to its original factory default settings





Power Input

Item	Content
Standard Power	DC 12V/1.5A
Power Range	DC 5~36V
Consumption	<500mA (12V)

Physical Characteristics

Item	Content
Housing	Iron, providing IP30 protection
Dimensions	206x135x28 mm
Weight	790g

Environmental Limits

Item	Content
Operating Temperature	-35~+75°C (-31~+167°F)
Storage Temperature	-40~+85°C (-40~+185°F)
Operating Humidity	95% (Non-condensing)

Chapter 2 Installation Introduction

2.1 General

The router must be installed correctly to make it work properly.

Warning: Forbid to install the router when powered!

2.2 Encasement List

Name	Quantity	Remark
Router host	1	
Cellular antenna (Male SMA)	2	
WIFI antenna (Female SMA)	1	
Network cable	1	
Console cable	1	optional
Power adapter	1	
Manual CD	1	
Certification card	1	
Maintenance card	1	

2.3 Installation and Cable Connection

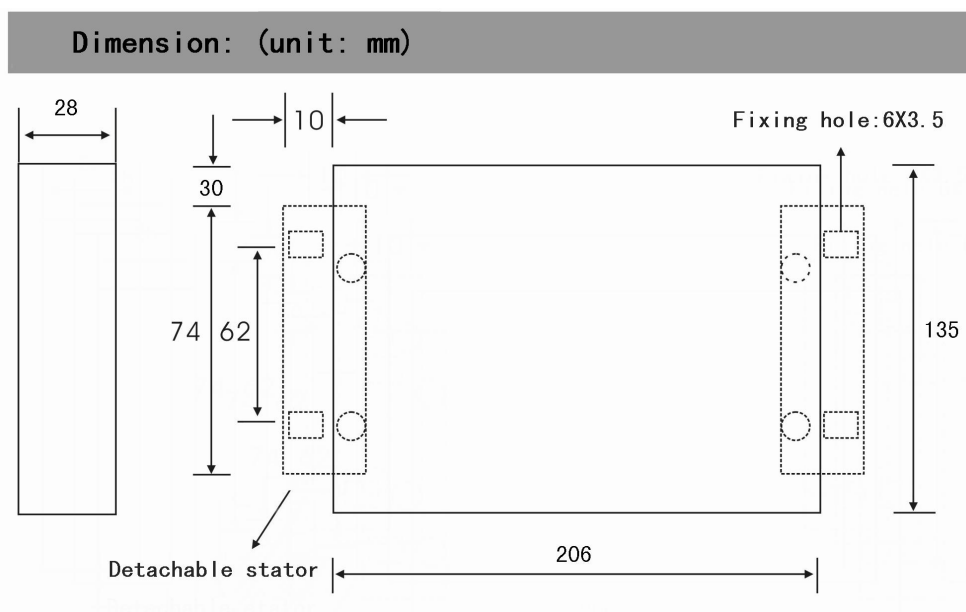

Installation of SIM/UIM card:

Firstly power off the router, and press the out button of the SIM/UIM card outlet with a needle object. Then the SIM/UIM card sheath will flick out at once. Put SIM/UIM card into the card sheath (Pay attention to put the side which has metal point outside), and insert card sheath back to the SIM/UIM card outlet.

Warning: Forbid to install SIM/UIM card when powered!

Installation of antenna:

Screw the SMA male pin of the cellular antenna to the female SMA interface of the router with sign “ANT-M” and “ANT-A”.

Screw the SMA female pin of the WIFI antenna to the male SMA interface of the router with sign “WIFI”.

Warning: The cellular antenna and the WIFI antenna can not be connected wrongly. And the antennas must be screwed tightly, or the signal quality of antenna will be influenced!

Installation of cable:

Insert one end of the network cable into the switch interface with sign “Local Network”, and insert the other end into the Ethernet interface of user’s device. The signal connection of network direct cable is as follows:

RJ45-1	RJ45-2
1	1
2	2
3	3
4	4
5	5
6	6
7	7
8	8

Insert the RJ45 end of the console cable into the RJ45 outlet with sign “console”, and insert the DB9F end of the console cable into the RS232 serial interface of user’s device.

The signal connection of the console cable is as follows:

RJ45	DB9F
1	8
2	6
3	2
4	1
5	5
6	3
7	4
8	7

The signal definition of the DB9F serial communication interface is as follows:

Pin	RS232 signal name	The direction for Router
1	DCD	output
2	RXD	output
3	TXD	input
4	DTR	input
5	GND	
6	DSR	output
7	RTS	input
8	CTS	output

2.4 Power

The power range of the router is DC 5~36V.

Warning: When we use other power, we should make sure that the power can supply power above 7W.

We recommend user to use the standard DC 12V/1.5A power.

2.5 Indicator Lights Introduction

The router provides following indicator lights: "Power", "System", "Online", "Alarm", "Local Network", "WAN", "WIFI", "Signal Strength".

Indicator Light	State	Introduction
Power	ON	Router is powered on
	OFF	Router is powered off or in the shutdown period of schedule boot&shutdown
System	BLINK	System works properly
	OFF	System does not work
Online	ON	Router has logged on network
	OFF	Router hasn't logged on network
Alarm	ON	SIM/UIM card does not work or the signal of the antenna is weak
	OFF	Router has no alarm
Local Network	OFF	The corresponding interface of switch is not connected
	ON / BLINK	The corresponding interface of switch is connected /Communicating
WAN	OFF	The interface of WAN is not connected

	ON / BLINK	The interface of WAN is connected /Communicating
WIFI	OFF	WIFI is not active
	ON	WIFI is active
Signal Strength	One Light ON	Signal strength is weak
	Two Lights ON	Signal strength is medium
	Three Lights ON	Signal strength is good

2.6 Reset Button Introduction

The router has a “Reset” button to restore it to its original factory default settings. When user press the “Reset” button for up to 15s, the router will restore to its original factory default settings and restart automatically.

Chapter 3 Configuration and Management

This chapter describes how to configure and manage the router.

3.1 Configuration Connection

Before configuration, you should connect the router and your configuration PC with the supplied network cable. Plug the cable’s one end into the Local Network port of the router, and another end into your configure PC’s Ethernet port. The connection diagram is as following:

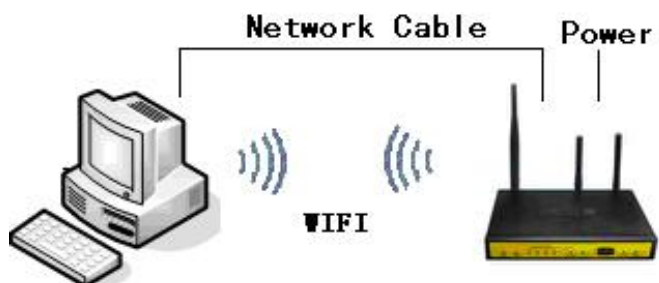

Please modify the IP address of PC as the same network segment address of the router, for instance, 192.168.1.9. Modify the mask code of PC as 255.255.255.0 and set the default gateway of PC as the router’s IP address (192.168.1.1).

3.2 Access the Configuration Web Page

The chapter is to present main functions of each page. Users visit page tool via web browser after connect users' PC to the router. There are eleven main pages: Setting, Wireless, Service, VPN, Security, Access Restrictions, NAT, QoS Setting, Applications, Management and Status. Users enable to browse slave pages by click one main page..

Users can open IE or other explorers and enter the router's default IP address of 192.168.1.1 on address bar, then press the botton of Enter to visit page Web management tool of the router. The users login in the web page at the first name, there will display a page shows as blow to tip users to modify the default user name and password of the router. Users have to click "change password" to make it work if they modify user name and password.

Router Management

Your Router is currently not protected and uses an unsafe default username and password combination, please change it using the following dialog!

Router Password

Router Username	<input type="text" value="admin"/>
Router Password	<input type="password" value="••••"/>
Re-enter to confirm	<input type="password" value="••••"/>

After access to the information main page

<p>Menu</p> <ul style="list-style-type: none"> Setup Wireless Services VPN Security NAT Access Restrictions QoS Setting Applications Administration Status 	<p>System Information</p> <table style="width: 100%; border-collapse: collapse;"> <tr> <td colspan="2">Router</td> </tr> <tr> <td>Router Name</td> <td>Router</td> </tr> <tr> <td>Router Model</td> <td>Router</td> </tr> <tr> <td>LAN MAC</td> <td>00:0C:43:8C:B6:D6</td> </tr> <tr> <td>WAN MAC</td> <td>00:0C:43:8C:B6:D7</td> </tr> <tr> <td>Wireless MAC</td> <td>00:0C:43:8C:B6:D8</td> </tr> <tr> <td>WAN IP</td> <td>192.168.9.223</td> </tr> <tr> <td>LAN IP</td> <td>192.168.1.1</td> </tr> </table> <table style="width: 100%; border-collapse: collapse;"> <tr> <td colspan="2">Wireless</td> </tr> <tr> <td>Radio</td> <td>Radio is On</td> </tr> <tr> <td>Mode</td> <td>AP</td> </tr> <tr> <td>Network</td> <td>Mixed</td> </tr> <tr> <td>SSID</td> <td>ssid-7620a</td> </tr> <tr> <td>Channel</td> <td>6 (2437 MHz)</td> </tr> <tr> <td>TX Power</td> <td>71 mW</td> </tr> <tr> <td>Rate</td> <td>300 Mb/s</td> </tr> </table> <table style="width: 100%; border-collapse: collapse;"> <tr> <td colspan="2">Wireless Packet Info</td> </tr> <tr> <td>Received (RX)</td> <td>0 OK, no error</td> </tr> <tr> <td>Transmitted (TX)</td> <td>0 OK, no error</td> </tr> </table>	Router		Router Name	Router	Router Model	Router	LAN MAC	00:0C:43:8C:B6:D6	WAN MAC	00:0C:43:8C:B6:D7	Wireless MAC	00:0C:43:8C:B6:D8	WAN IP	192.168.9.223	LAN IP	192.168.1.1	Wireless		Radio	Radio is On	Mode	AP	Network	Mixed	SSID	ssid-7620a	Channel	6 (2437 MHz)	TX Power	71 mW	Rate	300 Mb/s	Wireless Packet Info		Received (RX)	0 OK, no error	Transmitted (TX)	0 OK, no error
Router																																							
Router Name	Router																																						
Router Model	Router																																						
LAN MAC	00:0C:43:8C:B6:D6																																						
WAN MAC	00:0C:43:8C:B6:D7																																						
Wireless MAC	00:0C:43:8C:B6:D8																																						
WAN IP	192.168.9.223																																						
LAN IP	192.168.1.1																																						
Wireless																																							
Radio	Radio is On																																						
Mode	AP																																						
Network	Mixed																																						
SSID	ssid-7620a																																						
Channel	6 (2437 MHz)																																						
TX Power	71 mW																																						
Rate	300 Mb/s																																						
Wireless Packet Info																																							
Received (RX)	0 OK, no error																																						
Transmitted (TX)	0 OK, no error																																						

Users need to input user name and password if it is their first time to login.



Input correct user name and password to visit relevant menu page. Default user name is admin, password is admin. (available to modify user name and password on management page, then click submit)

3.3 Management and configuration

3.3.1 Setting

The Setup screen is the first screen users will see when accessing the router. Most users will be able to configure the router and get it work properly using only the settings on this screen. Some Internet Service Providers (ISPs) will require users to enter specific information, such as User Name, Password, IP Address, Default Gateway Address, or DNS IP Address. These information can be obtained from your ISP, if required.

3.3.1.1 Basic Setting

WAN Connection Type

Seven Ways: Disabled, Static IP, Automatic Configuration-DHCP, PPPOE, PPTP, L2TP, 3G/UNMTS/4G/LTE

Disabled

Connection Type

Forbid the setting of WAN port connection type

Static IP

Connection Type	Static IP
WAN IP Address	0 . 0 . 0 . 0
Subnet Mask	0 . 0 . 0 . 0
Gateway	0 . 0 . 0 . 0
Static DNS 1	0 . 0 . 0 . 0
Static DNS 2	0 . 0 . 0 . 0
Static DNS 3	0 . 0 . 0 . 0

WAN IP Address: Users set IP address by their own or ISP assigns

Subnet Mask: Users set subnet mask by their own or ISP assigns

Gateway: Users set gateway by their own or ISP assigns

Static DNS1/DNS2/DNS3: Users set static DNS by their own or ISP assigns

Automatic Configuration-DHCP

Connection Type	Automatic Configuration - DHCP
-----------------	--------------------------------

IP address of WAN port gets automatic via DHCP

PPPOE

Connection Type	PPPoE	
User Name	<input type="text"/>	
Password	<input type="text"/>	<input type="checkbox"/> Unmask
Service Name	<input type="text"/>	
PPP Compression (MPPC)	<input type="radio"/> Enable <input checked="" type="radio"/> Disable	
T-Home VDSL VLAN 7/8 Tagging	<input type="radio"/> Enable <input checked="" type="radio"/> Disable	
MPPE Encryption	<input type="text"/>	
Single Line Multi Link	<input type="checkbox"/>	

User Name: login the Internet

Password: login the Internet

Service Name: provided by ISP server, if not, keep it null

PPP Compression (MPPC): provides a method to negotiation and use of compressed in PPP encapsulation link protocol

T-Home VDSL VLAN 7/8 Tagging: enable to support the front of the modem is vdsl

MPPE Encryption: Microsoft point to point encryption. It is used to encrypt the point-to-point link connection agreement of the encrypted data packet

Single Line Multi Link: enable single line link or disable multi link

PPTP

Connection Type	<input type="text" value="PPTP"/>
Use DHCP	<input type="radio"/> Yes <input checked="" type="radio"/> No
WAN IP Address	<input type="text" value="0"/> . <input type="text" value="0"/> . <input type="text" value="0"/> . <input type="text" value="0"/>
Subnet Mask	<input type="text" value="0"/> . <input type="text" value="0"/> . <input type="text" value="0"/> . <input type="text" value="0"/>
Gateway	<input type="text" value="0"/> . <input type="text" value="0"/> . <input type="text" value="0"/> . <input type="text" value="0"/>
Gateway (PPTP Server)	<input type="text"/>
User Name	<input type="text"/>
Password	<input type="text"/> <input type="checkbox"/> Unmask
PPTP Encryption	<input type="radio"/> Enable <input checked="" type="radio"/> Disable
Disable Packet Reordering	<input checked="" type="radio"/> Enable <input type="radio"/> Disable
Additional PPTP Options	<input type="text"/>

Use DHCP: gets IP address, then connect to the server via PPIP

Gateway (PPTP Server): Users set gateway (PPTP server) by their own or ISP assigns

User Name: login the Internet

Password: login the Internet

PPTP Encryption: encrypt PPTP data

Disable Packet Reordering: enable or disable the function

Additional PPTP Options: add extra PPTP functions options for PPTP client, set if needed

L2TP

Connection Type	<input type="text" value="L2TP"/>
User Name	<input type="text"/>
Password	<input type="text"/> <input type="checkbox"/> Unmask
Gateway (L2TP Server)	<input type="text"/>
Require CHAP	<input checked="" type="radio"/> Yes <input type="radio"/> No
Refuse PAP	<input checked="" type="radio"/> Yes <input type="radio"/> No
Require Authentication	<input checked="" type="radio"/> Yes <input type="radio"/> No

User Name: login the Internet

Password: login the Internet

Gateway (L2TP Server): users set L2TP server by their own or ISP assigns

Require CHAP: Yes or No

Refuse PAP: Yes or No

Require Authentication: Yes or No

3G/UMTS/4G/LTE

Connection Type	<input type="text" value="3G/UMTS/4G/LTE"/>	
User Name	<input type="text"/>	
Password	<input type="text"/>	<input type="checkbox"/> Unmask
Dial String	<input type="text" value="*99***1# (UMTS/3G/3.5G)"/>	
APN	<input type="text"/>	
PIN	<input type="text"/>	<input type="checkbox"/> Unmask

User Name: login users' ISP(Internet Service Provider)

Password: login users' ISP

Dial String: dial number of users' ISP

APN: access point name of users' ISP

PIN: PIN code of users' SIM card

Connection type

Connection type

Connection type: Auto, Force 3G, Force 2G, Prefer 3G, Prefer 2G options. If using 4G module, there has 4G network option. Users select different mode depending on their need

Keep Online

Keep Online Detection	<input type="text" value="Ping"/>
Detection Interval	<input type="text" value="60"/> Sec.
Primary Detection Server IP	<input type="text" value="166"/> . <input type="text" value="111"/> . <input type="text" value="8"/> . <input type="text" value="238"/>
Backup Detection Server IP	<input type="text" value="202"/> . <input type="text" value="119"/> . <input type="text" value="32"/> . <input type="text" value="102"/>

This function is used to detect whether the Internet connection is active, if users set it and when the router detect the connection is inactive, it will redial to users' ISP immediately to make the connection active.

Detection Method:

None: do not set this function

Ping: Send ping packet to detect the connection, when choose this method, users should also configure "Detection Interval", "Primary Detection Server IP" and "Backup Detection Server IP" items.

Route: Detect connection with route method, when choose this method, users should

also configure "Detection Interval", "Primary Detection Server IP" and "Backup Detection Server IP" items.

PPP: Detect connection with PPP method, when choose this method, users should also configure "Detection Interval" item.

Detection Interval: time interval between two detections, unit is second

Primary Detection Server IP: the server used to response the router's detection packet. This item is only valid for method "Ping" and "Route".

Backup Detection Server IP: the server used to response the router's detection packet. This item is valid for method "Ping" and "Route".

Note: When users choose the "Route" or "Ping" method, it's quite important to make sure that the "Primary Detection Server IP" and "Backup Detection Server IP" are usable and stable, because they have to response the detection packet frequently.

Connection Strategy

Connection Strategy Connect on Demand: Max Idle Time Min. Keep Alive: Redial Period Sec.

Connection Strategy: one way is Connect on Demand, that is the link turnoff automatic under the situation that the ready link is idle and idle time meets users' configuration requirement, but it will connect again if users visit Internet. The other way is to keep alive, that is the link enable to dial again when reaching the re-dial period users set after disconnection.

Force reconnect Enable Disable
Time :

Force reconnect: this option schedules the pppoe or 3G reconnection by killing the pppd daemon and restart it.

Time: needed time to reconnect

STP

STP Enable Disable

STP (Spanning Tree Protocol) can be applied to loop network. Through certain algorithm achieves path redundancy, and loop network cuts to tree-based network without loop in the meantime, thus to avoid the hyperplasia and infinite circulation of a message in the loop network

Optional Configuration

Router Name	<input type="text" value="Four-Faith"/>
Host Name	<input type="text"/>
Domain Name	<input type="text"/>
MTU	Auto <input type="button" value="v"/> <input type="text" value="1500"/>

Router Name: set router name

Host Name: ISP provides

Domain Name: ISP provides

MTU: auto (1500) and manual (1200-1492 in PPPOE/PPTP/L2TP mode, 576-16320 in other modes)

Router Internal Network Settings

Router IP

Local IP Address	<input type="text" value="192"/> . <input type="text" value="168"/> . <input type="text" value="1"/> . <input type="text" value="1"/>
Subnet Mask	<input type="text" value="255"/> . <input type="text" value="255"/> . <input type="text" value="255"/> . <input type="text" value="0"/>
Gateway	<input type="text" value="0"/> . <input type="text" value="0"/> . <input type="text" value="0"/> . <input type="text" value="0"/>
Local DNS	<input type="text" value="0"/> . <input type="text" value="0"/> . <input type="text" value="0"/> . <input type="text" value="0"/>

Local IP Address: IP address of the router

Subnet Mask: the subnet mask of the router

Gateway: set internal gateway of the router. If default, internal gateway is the address of the router

Local DNS: DNS server is auto assigned by network operator server. Users enable to use their own DNS server or other stable DNS servers, if not, keep it default

Network Address Server Settings (DHCP)

These settings for the router's Dynamic Host Configuration Protocol (DHCP) server functionality

configuration. The Router can serve as a network DHCP server. DHCP server automatically assigns an IP address for each computer in the network. If they choose to enable the router's DHCP server option, users can set all the computers on the LAN to automatically obtain an IP address and DNS, and make sure no other DHCP server in the network.

DHCP Type	<input type="text" value="DHCP Server"/>
DHCP Server	<input checked="" type="radio"/> Enable <input type="radio"/> Disable
Start IP Address	192.168.1. <input type="text" value="100"/>
Maximum DHCP Users	<input type="text" value="50"/>
Client Lease Time	<input type="text" value="1440"/> minutes
Static DNS 1	<input type="text" value="0"/> . <input type="text" value="0"/> . <input type="text" value="0"/> . <input type="text" value="0"/>
Static DNS 2	<input type="text" value="0"/> . <input type="text" value="0"/> . <input type="text" value="0"/> . <input type="text" value="0"/>
Static DNS 3	<input type="text" value="0"/> . <input type="text" value="0"/> . <input type="text" value="0"/> . <input type="text" value="0"/>
WINS	<input type="text" value="0"/> . <input type="text" value="0"/> . <input type="text" value="0"/> . <input type="text" value="0"/>
Use DNSMasq for DHCP	<input checked="" type="checkbox"/>
Use DNSMasq for DNS	<input checked="" type="checkbox"/>
DHCP-Authoritative	<input checked="" type="checkbox"/>

DHCP Type: DHCP Server and DHCP Forwarder

Enter DHCP Server if set DHCP Type to DHCP Forwarder as blow:

DHCP Type	<input type="text" value="DHCP Forwarder"/>
DHCP Server	<input type="text" value="0"/> . <input type="text" value="0"/> . <input type="text" value="0"/> . <input type="text" value="0"/>

DHCP Server: keep the default Enable to enable the router's DHCP server option. If users have already have a DHCP server on their network or users do not want a DHCP server, then select Disable

Start IP Address: enter a numerical value for the DHCP server to start with when issuing IP addresses. Do not start with 192.168.1.1 (the router's own IP address).

Maximum DHCP Users: enter the maximum number of PCs that users want the DHCP server to assign IP addresses to. The absolute maximum is 253 if 192.168.1.2 is users' starting IP address.

Client Lease Time: the Client Lease Time is the amount of time a network user will be allowed connection to the router with their current dynamic IP address. Enter the amount of time, in minutes, that the user will be "leased" this dynamic IP address.

Static DNS (1-3): the Domain Name System (DNS) is how the Internet translates domain or website names into Internet addresses or URLs. Users' ISP will provide them with at least one DNS Server IP address. If users wish to utilize another, enter that IP address in one of these fields. Users can enter up to three DNS Server IP addresses here. The router will utilize them for quicker access to functioning DNS servers.

WINS: the Windows Internet Naming Service (WINS) manages each PC's interaction with the Internet. If users use a WINS server, enter that server's IP address here. Otherwise, leave it blank.

DNSMasq: users' domain name in the field of local search, increase the expansion of the host option, to adopt DNSMasq can assign IP addresses and DNS for the subnet, if select

DNSMasq, dhcpd service is used for the subnet IP address and DNS.

Time Settings

Select time zone of your location. To use local time, leave the checkmark in the box next to Use local time.

NTP Client	<input checked="" type="radio"/> Enable <input type="radio"/> Disable
Time Zone	UTC+08:00 ▼
Summer Time (DST)	last Sun Mar - last Sun Oct ▼
Server IP/Name	<input type="text"/>

NTP Client: Get the system time from NTP server

Time Zone: Time zone options

Summer Time (DST): set it depends on users' location

Server IP/Name: IP address of NTP server, up to 32 characters. If blank, the system will find a server by default

Adjust Time

Time	2012-3-15 9:16:20	<input type="button" value="Get"/>	<input type="button" value="Set"/>
------	-------------------	------------------------------------	------------------------------------

To adjust time by the system and refresh to get the time of the web, user can set to modify the time of the system. They can change to adjust time by manual to achieve adjust time by the system if the system fails to get NTP server

3.3.1.2 Dynamic DNS

If user's network has a permanently assigned IP address, users can register a domain name and have that name linked with their IP address by public Domain Name Servers (DNS). However, if their Internet account uses a dynamically assigned IP address, users will not know in advance what their IP address will be, and the address can change frequently. In this case, users can use a commercial dynamic DNS service, which allows them to register their domain to their IP address, and will forward traffic directed at their domain to their frequently-changing IP address.

DDNS Service: router currently support DynDNS, freedns, Zoneedit, NO-IP, 3322, easyDNS, TZO, DynSIP and Custom based on the user.

DDNS Service	3322.org ▼
--------------	------------

User Name	<input type="text"/>
Password	<input type="password"/> <input type="checkbox"/> Unmask
Host Name	<input type="text"/>
Type	Dynamic <input type="button" value="v"/>
Wildcard	<input type="checkbox"/>
Do not use external ip check	<input checked="" type="radio"/> Yes <input type="radio"/> No

User Name: users register in DDNS server, up to 64 characteristic

Password: password for the user name that users register in DDNS server, up to 32 characteristic

Host Name: users register in DDNS server, no limited for input characteristic for now

Type: depends on the server

Wildcard: support wildcard or not, the default is OFF. ON means *.host.3322.org is equal to host.3322.org

Do not use external ip check: enable or disable the function of 'do not use external ip check'

Force Update Interval (Default: 10 Days, Range: 1 - 60)

Force Update Interval: unit is day, try forcing the update dynamic DNS to the server by setted days

Status

DDNS Status

```
Fri Nov 25 13:58:32 2011: INADYN: Started 'INADYN Advanced version 1.96-ADV' - dynamic DNS updater.  
Fri Nov 25 13:58:32 2011: INADYN: IP read from cache file is '192.168.8.222'. No update required.  
Fri Nov 25 13:58:32 2011: I:INADYN: IP address for alias 'testsixin.3322.org' needs update to '192.168.8.38'  
Fri Nov 25 13:58:33 2011: I:INADYN: Alias 'testsixin.3322.org' to IP '192.168.8.38' updated successfully.
```

DDNS Status shows connection log information

3.3.1.3 Clone MAC Address

Some ISP need the users to register their MAC address. The users can clone the router MAC address to their MAC address registered in ISP if they do not want to re-register their MAC address

Enable Disable

Clone LAN MAC

Clone WAN MAC

[Get Current PC MAC Address](#)

Clone Wireless MAC

Clone MAC address can clone three parts: Clone LAN MAC, Clone WAN MAC, Clone Wireless MAC.

Noted that one MAC address is 48 characteristic, can not be set to the multicast address, the first byte must be even. And MAC address value of network bridge br0 is determined by the smaller value of wireless MAC address and LAN port MAC address.

3.3.1.4 Advanced Router

Operating Mode: Gateway and Router

Operating Mode

Operating Mode

If the router is hosting users' Internet connection, select Gateway mode. If another router exists on their network, select Router mode.

Dynamic Routing

Dynamic Routing

Interface

Dynamic Routing enables the router to automatically adjust to physical changes in the network's layout and exchange routing tables with other routers. The router determines the network packets' route based on the fewest number of hops between the source and destination.

To enable the Dynamic Routing feature for the WAN side, select WAN. To enable this feature for the LAN and wireless side, select LAN&WLAN. To enable the feature for both the WAN and LAN, select Both. To disable the Dynamic Routing feature for all data transmissions, keep the default setting, Disable.

Note:Dynamic Routing is not available in Gateway mode

Static Routing

Static Routing

Select set number:

Route Name:

Metric:

Destination LAN NET: ...

Subnet Mask: ...

Gateway: ...

Interface:

Select set number: 1-50

Route Name: defined routing name by users, up to 25 characters

Metric: 0-9999

Destination LAN NET: the Destination IP Address is the address of the network or host to which users want to assign a static route

Subnet Mask: the Subnet Mask determines which portion of an IP address is the network portion, and which portion is the host portion

Gateway: IP address of the gateway device that allows for contact between the router and the network or host.

Interface: indicate users whether the Destination IP Address is on the LAN & WLAN (internal wired and wireless networks), the WAN (Internet), or Loopback (a dummy network in which one PC acts like a network, necessary for certain software programs)

Show Routing Table

Routing Table Entry List			
Destination LAN NET	Subnet Mask	Gateway	Interface
192.168.1.1	255.255.255.255	0.0.0.0	WAN
192.168.1.0	255.255.255.0	0.0.0.0	LAN & WLAN
192.168.1.0	255.255.255.0	0.0.0.0	WAN
169.254.0.0	255.255.0.0	0.0.0.0	WAN
0.0.0.0	0.0.0.0	192.168.1.1	LAN & WLAN

3.3.1.5 VLANs

VLAN

VLAN	Port					Assigned To Bridge
	W	1	2	3	4	
1	<input type="checkbox"/>	<input checked="" type="checkbox"/>	<input checked="" type="checkbox"/>	<input checked="" type="checkbox"/>	<input checked="" type="checkbox"/>	LAN
2	<input checked="" type="checkbox"/>	<input type="checkbox"/>	<input type="checkbox"/>	<input type="checkbox"/>	<input type="checkbox"/>	None
3	<input type="checkbox"/>	<input type="checkbox"/>	<input type="checkbox"/>	<input type="checkbox"/>	<input type="checkbox"/>	LAN
4	<input type="checkbox"/>	<input type="checkbox"/>	<input type="checkbox"/>	<input type="checkbox"/>	<input type="checkbox"/>	LAN
5	<input type="checkbox"/>	<input type="checkbox"/>	<input type="checkbox"/>	<input type="checkbox"/>	<input type="checkbox"/>	LAN
6	<input type="checkbox"/>	<input type="checkbox"/>	<input type="checkbox"/>	<input type="checkbox"/>	<input type="checkbox"/>	None
7	<input type="checkbox"/>	<input type="checkbox"/>	<input type="checkbox"/>	<input type="checkbox"/>	<input type="checkbox"/>	None
8	<input type="checkbox"/>	<input type="checkbox"/>	<input type="checkbox"/>	<input type="checkbox"/>	<input type="checkbox"/>	None
9	<input type="checkbox"/>	<input type="checkbox"/>	<input type="checkbox"/>	<input type="checkbox"/>	<input type="checkbox"/>	None
10	<input type="checkbox"/>	<input type="checkbox"/>	<input type="checkbox"/>	<input type="checkbox"/>	<input type="checkbox"/>	None
11	<input type="checkbox"/>	<input type="checkbox"/>	<input type="checkbox"/>	<input type="checkbox"/>	<input type="checkbox"/>	None
12	<input type="checkbox"/>	<input type="checkbox"/>	<input type="checkbox"/>	<input type="checkbox"/>	<input type="checkbox"/>	None
13	<input type="checkbox"/>	<input type="checkbox"/>	<input type="checkbox"/>	<input type="checkbox"/>	<input type="checkbox"/>	None
14	<input type="checkbox"/>	<input type="checkbox"/>	<input type="checkbox"/>	<input type="checkbox"/>	<input type="checkbox"/>	None
15	<input type="checkbox"/>	<input type="checkbox"/>	<input type="checkbox"/>	<input type="checkbox"/>	<input type="checkbox"/>	None

VLANs function is to divide different VLAN ports by users' will. The system supports 15 VLAN port from VLAN1-VLAN15. However there is only 5 time ports (1 WAN port and 4 LAN port) divided by users themselves, and LAN port and WAN port disable to divide into one VLAN port meanwhile.

3.3.1.6 Networking

Bridging

Create Bridge

Bridge 0 STP Prio MTU

Assign to Bridge

Current Bridging Table

Bridge Name	STP enabled	Interfaces
br0	no	vlan0 ra0

Bridging-Create Bridge: creates a new empty network bridge for later use. STP means Spanning Tree Protocol and with PRIO users are able to set the bridge priority order. The lowest number has the highest priority.

Bridging - Assign to Bridge: allows users to assign any valid interface to a network bridge. Consider setting the Wireless Interface options to Bridged if they want to assign any Wireless Interface here. Any system specific bridge setting can be overridden here in this field.

Current Bridging Table: shows current bridging table

Create steps as below:

Click 'Add' to create a new bridge, configuration is as below:

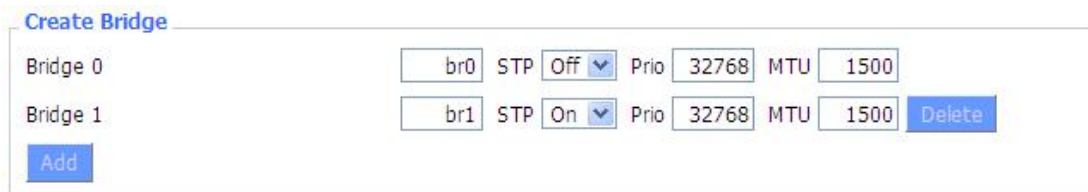

Create bridge option: the first br0 means bridge name. STP means to on/off spanning tree protocol. Prio means priority level of STP, the smaller the number, the higher the level. MTU means maximum transfer unit, default is 1500, delete if it is not need. And then click 'Save' or 'Add'. Bride properties is as below:



Enter relevant bridge IP address and subnet mask, click 'Add' to create a bridge.

Note: Only create a bride can apply it.

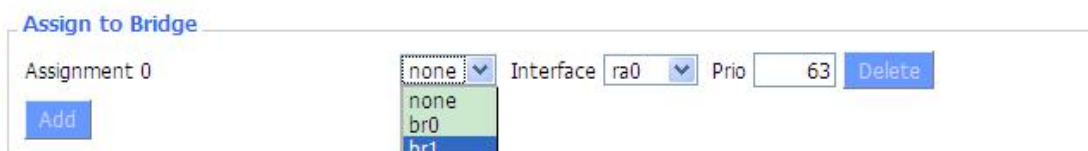

Assign to Bridge option: to assign different ports to created bridge. For example: assign port (wireless port) is ra0 in br1 bridge as below:

Prio means priority level: work if multiple ports are within the same bridge. The smaller the number, the higher the level. Click 'Add' to take it effect.

Note: corresponding interface of WAN ports interface should not be binding, this bridge function is basically used for LAN port, and should not be binding with WAN port

If bind success, bridge binding list in the list of current bridging table is as below:

Current Bridging Table

Bridge Name	STP enabled	Interfaces
br0	no	vlan0
br1	yes	ra0

[Back to previous page](#)

To make br1 bridge has the same function with DHCP assigned address, users need to set multiple DHCP function, see the introduction of multi-channel DHCPD:

Port Setup

Network Configuration eth2	<input type="radio"/> Unbridged	<input checked="" type="radio"/> Default
Network Configuration vlan0	<input type="radio"/> Unbridged	<input checked="" type="radio"/> Default
Network Configuration ra0	<input type="radio"/> Unbridged	<input checked="" type="radio"/> Default
Network Configuration apcli0	<input type="radio"/> Unbridged	<input checked="" type="radio"/> Default
Network Configuration wds0	<input type="radio"/> Unbridged	<input checked="" type="radio"/> Default
Network Configuration wds1	<input type="radio"/> Unbridged	<input checked="" type="radio"/> Default
Network Configuration wds2	<input type="radio"/> Unbridged	<input checked="" type="radio"/> Default
Network Configuration wds3	<input type="radio"/> Unbridged	<input checked="" type="radio"/> Default
Network Configuration br0	<input type="radio"/> Unbridged	<input checked="" type="radio"/> Default

Port Setup: Set the port property, the default is not set

Network Configuration ra0 Unbridged Default

MTU

Multicast forwarding Enable Disable

Masquerade / NAT Enable Disable

IP Address ...

Subnet Mask ...

Choose not bridge to set the port's own properties, detailed properties are as below:

MTU: maximum transfer unit

Multicast forwarding: enable or disable multicast forwarding

Masquerade/NAT: enable or disable Masquerade/NAT

IP Address: set ra0's IP address, and do not conflict with other ports or bridge

Subnet Mask: set the port's subnet mask

Multiple DHCP Server

DHCP 0 ra0 On Start Max Leasetime

Multiple DHCPD: using multiple DHCP service. Click 'Add' in multiple DHCP server to appear relevant configuration. The first means the name of port or bridge (do not be configured as eth0), the second means whether to on DHCP. Start means start address, Max means maximum assigned DHCP clients, Leasetime means the client lease time, the unit is second, click 'Save' or 'Apply' to put it into effect after setting.

Note: Only configure and click 'Save' can configure the next, can not configure multiple DHCP at the same time.

3.3.2 Wireless

3.3.2.1 Basic Settings

Wireless Physical Interface wl0 [2.4 GHz]

Wireless Network Enable Disable

Physical Interface ra0 - SSID [dd-junjinlee] HWAddr [00:AA:BB:CC:DD:15]

Wireless Mode AP

Wireless Network Mode N-Only

802.11n Transmission Mode Mixed

Wireless Network Name (SSID)

Wireless Channel 11 - 2.462 GHz

Channel Width 40 MHz

Extension Channel upper

Wireless SSID Broadcast Enable Disable

Network Configuration Unbridged Bridged

Virtual Interfaces

Wireless Network:“Eanble”, radio on.
 “Disable”, radio off.

Wireless Mode:AP, Client, Adhoc, Repeater, Repeater Bridge four options.

Wireless Network Mode:

Mixed:Support 802.11b, 802.11g, 802.11n wireless devices.

BG-Mixed:Support 802.11b, 802.11g wireless devices.

B-only:Only supports the 802.11b standard wireless devices.

B-only:Only supports the 802.11b standard wireless devices.

G-only:Only supports the 802.11g standard wireless devices.

NG-Mixed:Support 802.11g, 802.11n wireless devices.

N-only:Only supports the 802.11g standard wireless devices.

802.11n Transmission Mode:In the wireless network mode to "N-only" choose to transfer its transmission mode.

Greenfield: When you determine the surrounding environment, there is no other 802.11a/b/g devices use the same channel, use this mode to increase throughput. Other 802.11a/b/g devices use the same channel in the environment, the information you send may generate an error, re-issued.

Mixed:This mode is contrary to the green mode, but will reduce the throughput.

Wireless Network Name(SSID): The SSID is the network name shared among all devices in a wireless network. The SSID must be identical for all devices in the wireless network. It is case-sensitive and must not exceed 32 alphanumeric characters, which may be any keyboard character. Make sure this setting is the same for all devices in your wireless network..

Wireless Channel:A total of 1-13 channels to choose more than one wireless device environment, please try to avoid using the same channel with other devices..

Channel Width:20MHZ and 40MHZ.

Extension Channel:Channel for 40MHZ, you can choose upper or lower.

Wireless SSID Broadcast:

Enable:SSID broadcasting.

Disable:Hidden SSID.

Network Configuration:

Bridged:Bridge to the router, under normal circumstances, please select the bridge.

Unbridged:There is no bridge to the router, IP addresses need to manually configure.

Network Configuration	<input checked="" type="radio"/> Unbridged <input type="radio"/> Bridged
Multicast forwarding	<input type="radio"/> Enable <input checked="" type="radio"/> Disable
Masquerade / NAT	<input checked="" type="radio"/> Enable <input type="radio"/> Disable
IP Address	<input type="text" value="192"/> <input type="text" value="168"/> <input type="text" value="1"/> <input type="text" value="1"/>
Subnet Mask	<input type="text" value="255"/> <input type="text" value="255"/> <input type="text" value="0"/> <input type="text" value="0"/>

Virtual Interfaces:Click Add to add a virtual interface. Add successfully, click on the remove, you can remove the virtual interface.

Virtual Interfaces

Virtual Interfaces ra1 SSID [dd-wrt_vap] HWAddr [00:AA:BB:CC:DD:16]

Wireless Network Name (SSID)	<input type="text" value="dd-wrt_vap"/>
Wireless SSID Broadcast	<input checked="" type="radio"/> Enable <input type="radio"/> Disable
AP Isolation	<input type="radio"/> Enable <input checked="" type="radio"/> Disable
Network Configuration	<input type="radio"/> Unbridged <input checked="" type="radio"/> Bridged

AP Isolation:This setting isolates wireless clients so access to and from other wireless clients are stopped.

Note:Save your changes, after changing the "Wireless Mode", "Wireless Network Mode", "wireless width", "broadband" option, please click on this button, and then configure the other options.

3.3.2.2 Wireless Security

Wireless security options used to configure the security of your wireless network. This route is a total of seven kinds of wireless security mode. Disabled by default, not safe mode is enabled. Such as changes in Safe Mode, click Apply to take effect immediately.

Wireless Security wl0

Physical Interface ra0 SSID [dd-junjinlee] HWAddr [00:AA:BB:CC:DD:15]

Security Mode	<input type="text" value="Disabled"/>
---------------	---------------------------------------

Wireless Security w10

Physical Interface ra0 SSID [four-faith] HWAddr [00:0C:43:30:52:79]

Security Mode:

Authentication Type: Open Shared Key

Default Transmit Key: 1 2 3 4

Encryption:

ASCII/HEX: ASCII HEX

Passphrase:

Key 1:

Key 2:

Key 3:

Key 4:

WEP:Is a basic encryption algorithm is less secure than WPA.Use of WEP is discouraged due to security weaknesses, and one of the WPA modes should be used whenever possible. Only use WEP if you have clients that can only support WEP (usually older, 802.11b-only clients).

Authentication Type:Open or shared key.

Default Transmit Key:Select the key form Key 1 - Key 4 key.

Encryption:There are two levels of WEP encryption, 64-bit (40-bit) and 128-bit. To utilize WEP, select the desired encryption bit, and enter a passphrase or up to four WEP key in hexadecimal format. If you are using 64-bit (40-bit), then each key must consist of exactly 10 hexadecimal characters or 5 ASCII charceters. For 128-bit, each key must consist of exactly 26 hexadecimal characters. Valid hexadecimal characters are "0"-"9" and "A"-"F".

ASCII/HEX: ASCII, the keys is 5 bit ASCII characters/13bit ASCII characters.

HEX, the keys is 10bit/26 bit hex digits.

Passphrase:The letters and numbers used to generate a key.

Key1-Key4:Manually fill out or generated according to input the pass phrase.

Wireless Security w10

Physical Interface ra0 SSID [dd-junjinlee] HWAddr [00:AA:BB:CC:DD:15]

Security Mode:

WPA Algorithms:

WPA Shared Key: Unmask

Key Renewal Interval (in seconds): (Default: 3600, Range: 1 - 99999)

WPA Personal/WPA2 Personal/WPA2 Person Mixed: TKIP/AES/TKIP+AES , dynamic encryption keys. TKIP + AES, self-applicable TKIP or AES. WPA Person Mixed, allow WPA Personal and WPA2 Personal client mix.

WPA Shared Key:Between 8 and 63 ASCII character or hexadecimal digits..

Key Renewal Interval (in seconds) :1-99999.

Wireless Security w10

Physical Interface ra0 SSID [dd-junjinlee] HWAddr [00:AA:BB:CC:DD:15]

Security Mode	WPA Enterprise	
WPA Algorithms	AES	
Radius Auth Server Address	192.168.1.110	
Radius Auth Server Port	1812	(Default: 1812)
Radius Auth Shared Secret	<input type="checkbox"/> Unmask
Key Renewal Interval (in seconds)	3600	

WPA Enterprise/WPA2 Enterprise/WPA2 Enterprise Mixed: WPA Enterprise uses an external RADIUS server to perform user authentication.

WPA Algorithms: AES/TKIP/TPIP+AES.

Radius Auth Sever Address:The IP address of the RADIUS server.

Radius Auth Server Port:The RADIUS Port (default is 1812).

Radius Auth Shared Secret:The shared secret from the RADIUS server.

Key Renewal Interva(in seconds): 1-99999.

3.3.2.3 Wireless MAC Filter

The Wireless MAC Filter allows you to control which wireless-equipped PCs may or may not communicate with the router depending on their MAC addresses. For information how to get MAC addresses from Windows-PCs, see MAC Address Cloning for detailed instructions.

Wireless MAC Filter

ra0 - MAC Filter

Use Filter	<input checked="" type="radio"/> Enable <input type="radio"/> Disable
Filter Mode	<input checked="" type="radio"/> Prevent clients listed from accessing the wireless network <input type="radio"/> Permit only clients listed to access the wireless network

[Edit MAC Filter List](#)

Save
Apply Settings
Cancel Changes

Use Filter: Disabled by default. Select Enable to open the Wireless MAC Filter.

Filter Mode:

Prevent client listed from accessing the wireless network: If you want to block specific wireless-equipped PCs from communicating with the router, then keep the default setting, Prevent PCs listed from accessing the wireless network.

Permit only client listed to accessing the wireless network: If you want to allow specific wireless-equipped PCs to communicate with the router, then click the radio button next to Permit only PCs listed to access the wireless network.

Click the Edit MAC Filter List button. Enter the appropriate MAC addresses into the MAC fields

3.3.2.4 Advance Settings

The Wireless Advanced Settings screen allows you to customize data transmission settings. In most cases, the advanced settings on this screen should remain at their default values.

Advanced Wireless Settings

Advanced Settings

Basic Rate	Default <input type="button" value="v"/>	(Default: Default)
MIMO - Transmission Fixed Rate	Auto <input type="button" value="v"/>	(Default: Auto)
Transmission Fixed Rate	Auto <input type="button" value="v"/>	(Default: Auto)
CTS Protection Mode	<input checked="" type="radio"/> Auto <input type="radio"/> Disable	(Default: Auto)
Frame Burst	<input checked="" type="radio"/> Enable <input type="radio"/> Disable	
Beacon Interval	<input type="text" value="100"/>	(Default: 100ms, Range: 10 - 65535)
DTIM Interval	<input type="text" value="1"/>	(Default: 1, Range: 1 - 255)
Fragmentation Threshold	<input type="text" value="2346"/>	(Default: 2346, Range: 256 - 2346)
RTS Threshold	<input type="text" value="2347"/>	(Default: 2347, Range: 0 - 2347)
Max Associated Clients	<input type="text" value="128"/>	(Default: 128, Range: 1 - 256)
AP Isolation	<input type="radio"/> Enable <input checked="" type="radio"/> Disable	(Default: Disable)
TX Antenna	Auto <input type="button" value="v"/>	(Default: Auto)
RX Antenna	Auto <input type="button" value="v"/>	(Default: Auto)
Preamble	Long <input type="button" value="v"/>	(Default: Long)
Shortslot Override	Auto <input type="button" value="v"/>	(Default: Auto)
TX Power	<input type="text" value="71"/>	(Default: 71, Range: 1 - 251mW)
Wireless GUI Access	<input checked="" type="radio"/> Enable <input type="radio"/> Disable	(Default: Enable)

Basic Rate:The default value is set to Default. Depending on the wireless mode you have

selected, a default set of supported data rates will be selected. The default setting will ensure maximum compatibility with all devices. You may also choose to enable all data rates by selecting ALL. For compatibility with older Wireless-B devices, select 1-2Mbps.

MIMO-Transmission Fixed Rate:The default setting is Auto. The range is from 13.5 to 270Mbps. The rate of data transmission should be set depending on the speed of your wireless network. You can select from a range of transmission speeds, or keep the default setting, Auto, to have the router automatically use the fastest possible data rate and enable the Auto-Fallback feature. Auto-Fallback will negotiate the best possible connection speed between the router and a wireless client.

Transmission Fixed Rate:The default setting is Auto. The range is from 1 to 54Mbps. The rate of data transmission should be set depending on the speed of your wireless network. You can select from a range of transmission speeds, or keep the default setting, Auto, to have the router automatically use the fastest possible data rate and enable the Auto-Fallback feature. Auto-Fallback will negotiate the best possible connection speed between the router and a wireless client.

CTS Protection Mode:The default value is disabled. When set to Auto, a protection mechanism will ensure that your Wireless-B devices will connect to the Wireless-G router when many Wireless-G devices are present. However, performance of your Wireless-G devices may be decreased.

Frame Burst:The default value is disabled. Frame burst allows packet bursting which will increase overall network speed though this is only recommended for approx 1-3 wireless clients, Any more clients and there can be a negative result and throughput will be affected.

Beacon Interval:The default value is 100. Enter a value between 1 and 65,535 milliseconds. The Beacon Interval value indicates the frequency interval of the beacon. A beacon is a packet broadcast by the router to synchronize the wireless network. 50 is recommended in poor reception.

DTIM Interval:The default value is 1. This value, between 1 and 255, indicates the interval of the Delivery Traffic Indication Message (DTIM). A DTIM field is a countdown field informing clients of the next window for listening to broadcast and multicast messages. When the router has buffered broadcast or multicast messages for associated clients, it sends the next DTIM with a DTIM Interval value. Its clients hear the beacons and awaken to receive the broadcast and multicast messages.

Fragmentation Threshold:This value should remain at its default setting of 2346. The range is 256-2346 bytes. It specifies the maximum size for a packet before data is fragmented into multiple packets. If you experience a high packet error rate, you may slightly increase the Fragmentation Threshold. Setting the Fragmentation Threshold too low may result in poor network performance. Only minor modifications of this value are recommended.

RTS Threshold:This value should remain at its default setting of 2347. The range is 0-2347 bytes. Should you encounter inconsistent data flow, only minor modifications are recommended. If a network packet is smaller than the preset RTS threshold size, the

RTS/CTS mechanism will not be enabled. The router sends Request to Send (RTS) frames to a particular receiving station and negotiates the sending of a data frame. After receiving an RTS, the wireless station responds with a Clear to Send (CTS) frame to acknowledge the right to begin transmission.

Max Associated Clients:1-128.

AP Isolation:The default value is Off. This setting isolates wireless clients so access to and from other wireless clients are stopped.

TX Antenna/ RX Antenna:Values are Auto, Left, Right, default value is Auto. This is used in conjunction with external antennas to give them optimum performance. On some router models left and right antennas may be reversed depending on you point of view.

Preamble:Values are Long and Short, default value is Long. If your wireless device supports the short preamble and you are having trouble getting it to communicate with other 802.11b devices, make sure that it is set to use the long preamble.

Wireless GUI Access: The default value is Enabled. The setting allows access to the routers setup (GUI) from wireless clients. Disable this if you wish to block all wireless clients from accessing the setup pages.

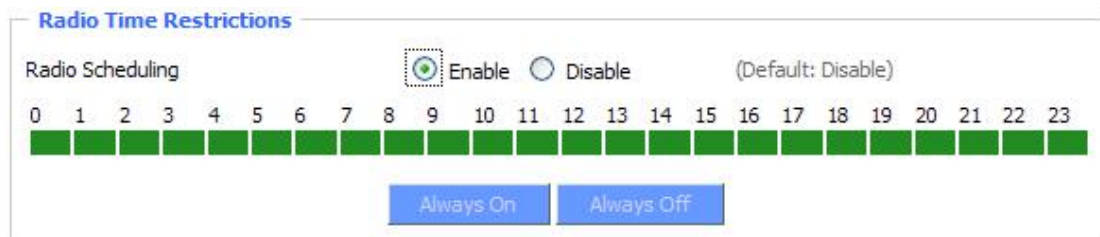

Radio Time Restrictions: The *Radio Times Restriction* facility constitutes a time switch for the radio. By default, the time switch is not active and the WLAN is permanently on. Enable the time switch, if you want to turn off the WLAN during some hours of the day. Hours during which the WLAN is on are marked in green, while red indicates that the radio is off. Clicking on the respective hour toggles between on and off.

Wireless Multimedia Support Settings

WMM Support Enable Disable (Default: Enable)

No-Acknowledgement Enable Disable (Default: Disable)

EDCA AP Parameters (AP to Client)						
	CWmin	CWmax	AIFSN	TXOP(b)	TXOP(a/g)	Admin Forced
Background	15	1023	7	0	0	<input type="checkbox"/>
Best Effort	15	63	3	0	0	<input type="checkbox"/>
Video	7	15	1	6016	3008	<input type="checkbox"/>
Voice	3	7	1	3264	1504	<input type="checkbox"/>

EDCA STA Parameters (Client to AP)						
	CWmin	CWmax	AIFSN	TXOP(b)	TXOP(a/g)	Admin Forced
Background	15	1023	7	0	0	<input type="checkbox"/>
Best Effort	15	1023	3	0	0	<input type="checkbox"/>
Video	7	15	2	6016	3008	<input type="checkbox"/>
Voice	3	7	2	3264	1504	<input type="checkbox"/>

WMM Tx retry limits, fallback limits and max rate parameters.					
	S. Retry	S. Fallbk	L. Retry	L. Fallbk	Max Rate
Background	7	3	4	2	0
Best Effort	7	3	4	2	0
Video	7	3	4	2	0
Voice	7	3	4	2	0

Wireless Multimedia Support Settings: Enable support of Wi-Fi Multimedia feature. Configuring QoS options consists of setting parameters on existing queues for different types of wireless traffic. You can configure different minimum and maximum wait times for the transmission of packets in each queue based on the requirements of the media being sent. Queues automatically provide minimum transmission delay for Voice, Video, multimedia, and mission critical applications, and rely on best-effort parameters for traditional IP data

No-Acknowledgement: This refers to the acknowledge policy used at the MAC level. Enabling no-acknowledgement can result in more efficient throughput but higher error rates in a noisy Radio Frequency (RF) environment

EDCA AP Parameters (AP to Client): This affects traffic flowing from the access point to the client station.

EDCA STA Parameters (Client to AP): This affects traffic flowing from the client station to the access point.

Background: Priority is low.

High throughput. Bulk data that requires maximum throughput and is not time-sensitive is sent to this queue (FTP data, for example).

Best Effort: Priority is Medium.

Medium throughput and delay. Most traditional IP data is sent to this queue.

Video: Priority is High.

Minimum delay. Time-sensitive video data is automatically sent to this queue.

voice: Priority is High.

Time-sensitive data like VoIP and streaming media are automatically sent to this queue.

CWmin: Minimum Contention Window. This parameter is input to the algorithm that determines the initial random backoff wait time ("window") for retry of a transmission. The value specified here in the Minimum Contention Window is the upper limit (in milliseconds) of a range from which the initial random backoff wait time is determined.

The first random number generated will be a number between 0 and the number specified here. If the first random backoff wait time expires before the data frame is sent, a retry counter is incremented and the random backoff value (window) is doubled. Doubling will continue until the size of the random backoff value reaches the number defined in the Maximum Contention Window. Valid values for the "cwmin" are 1, 3, 7, 15, 31, 63, 127, 255, 511, or 1024. The value for "cwmin" must be lower than the value for "CWmax".

Cmax: Maximum Contention Window. The value specified here in the Maximum Contention Window is the upper limit (in milliseconds) for the doubling of the random backoff value. This doubling continues until either the data frame is sent or the Maximum Contention Window size is reached. Once the Maximum Contention Window size is reached, retries will continue until a maximum number of retries allowed is reached. Valid values for the "cymax" are 1, 3, 7, 15, 31, 63, 127, 255, 511, or 1024. The value for "cymax" must be higher than the value for "CWmin".

AIFSN: The Arbitration Inter-Frame Spacing Number specifies a wait time (in milliseconds) for data frames.

TXOP(b)/ TXOP(a/g): Transmission Opportunity for "a" "b" and "g" modes is an interval of time when a WME AP has the right to initiate transmissions onto the wireless medium (WM). This value specifies (in milliseconds) the Transmission Opportunity (TXOP) for AP; that is, the interval of time when the WMM AP has the right to initiate transmissions on the wireless network.

3.3.2.5 WDS

WDS (Wireless Distribution System) is a Wireless Access Point mode that enables wireless bridging in which WDS APs communicate only with each other only (without allowing for wireless clients or stations to access them), and/or wireless repeating in which APs communicate both with each other and with wireless stations (at the expense of half the throughput). This firmware currently supports one types of WDS, LAN.

Wireless Distribution System

WDS Settings

Wireless MAC 00:AA:BB:CC:DD:15

LAN	00	00	00	00	00	00	
Disable	00	00	00	00	00	00	
Disable	00	00	00	00	00	00	
Disable	00	00	00	00	00	00	
Disable	00	00	00	00	00	00	
Disable	00	00	00	00	00	00	
Disable	00	00	00	00	00	00	
Disable	00	00	00	00	00	00	
Disable	00	00	00	00	00	00	
Disable	00	00	00	00	00	00	

Extra Options

Lazy WDS Enable Disable (Default: Disable)

Save Apply Settings Cancel Changes

LAN-type WDS

This is the easiest, and currently most common, type of WDS used for linking LANs. It is very simple to setup and requires no extra routing protocols or knowledge of networking. Simply put, it is pure bridging. A simple example would be extending the range of an existing AP by setting up a 2nd AP and connecting it to the first using LAN-type WDS.

1. Make sure you are using the same Wireless Settings on both routers and not any type of Wireless Security.
2. Find a drop-down selection that has Disabled displayed. Click this and select LAN, do the same on the other router.
3. On the first router, take the numbers next to Wireless MAC and enter them in to the second router on the same line that you set to "LAN".
4. Take the Wireless MAC from the second router and enter them on the first router.
5. Check for any typing errors and then click Save Settings.
6. Go to the Wireless Status page. You should see WDS Link and the Wireless MAC of the other router listed, with a signal reading. If the signal is "0dBm" then there may be something wrong. Check your antenna connections and configuration settings, and try again.
7. Once you have a good signal (-70dBm to -30dBm, -70dBm being lowest), you can

change the Internet Connection Type on the Basic Setup page of the second router to Disabled and set the *Gateway* to the LAN IP Address of the first router. You can now run normal tests to check if you are connected (like ping).

Lzay WDS: Default is disabled.

Note: WDS is only available in AP mode. Also Wireless encryption WPA2 and Wireless network mode B-Only are not supported under WDS.

3.3.3 Services

3.3.3.1 Services

DHCP Server

DHCPd assigns IP addresses to users local devices. While the main configuration is on the setup page users can program some nifty special functions here.

DHCP Server

Use JFFS2 for client lease DB (Not mounted)

Use NVRAM for client lease DB

Used Domain WAN

LAN Domain

Additional DHCPd Options

Static Leases

MAC Address	Host Name	IP Address	Client Lease Time
<input type="text"/>	<input type="text"/>	<input type="text"/>	<input type="text"/> minutes

Use NVRAM for client lease DB: users can store data to the system NVRAM area is enabled

Used domain: users can select here which domain the DHCP clients should get as their local domain. This can be the WAN domain set on the Setup screen or the LAN domain which can be set here.

LAN Domain: Users can define here their local LAN domain which is used as local domain for DNSmasq and DHCP service if chose above.

Static Leases: if users want to assign certain hosts a specific address then they can define them here. This is also the way to add hosts with a fixed address to the router's local DNS service (DNSmasq).

Additional DHCPd Options: some extra options users can set by entering them

DNSMasq

DNSMasq is a local DNS server. It will resolve all host names known to the router from dhcp (dynamic and static) as well as forwarding and caching DNS entries from remote DNS servers. Local DNS enables DHCP clients on the LAN to resolve static and dynamic DHCP hostnames.

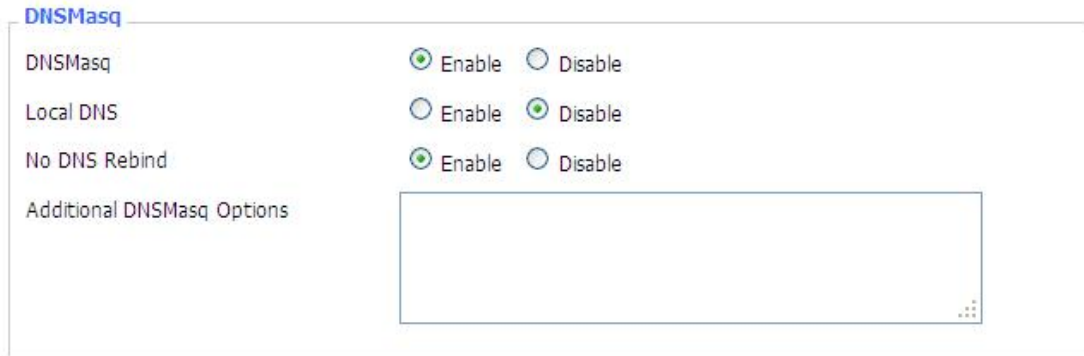

Local DNS: enables DHCP clients on the LAN to resolve static and dynamic DHCP hostnames

No DNS Rebind: when enabled, it can prevent an external attacker to access the router's internal Web interface. It is a security measure

Additional DNSMasq Options: some extra options users can set by entering them in Additional DNS Options.

For example:

Static

allocation:

dhcp-host=AB:CD:EF:11:22:33,192.168.0.10,myhost,myhost.domain,12h

max lease number: dhcp-lease-max=2

DHCP server IP range: dhcp-range=192.168.0.110,192.168.0.111,12h

SNMP

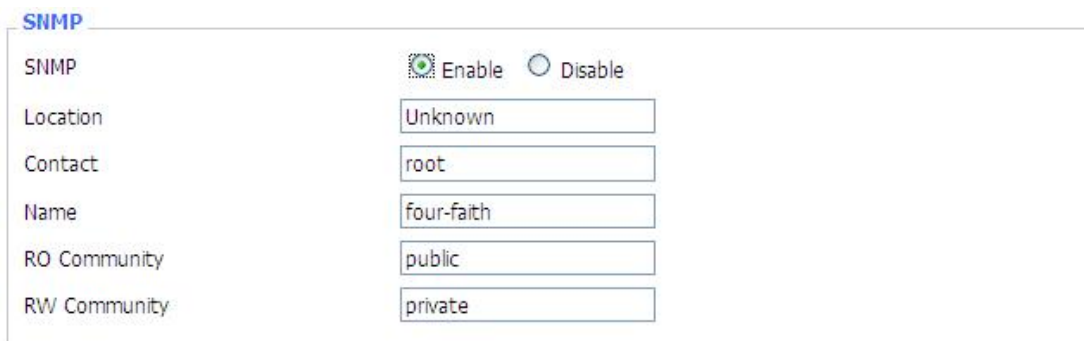

Location: equipment location

Contact: contact this equipment management

Name: device name

RO Community: SNMP RO community name, the default is public, Only to read.

RW Community: SNMP RW community name, the default is private, Read-write

permissions

SSHD

Enabling SSHd allows users to access the Linux OS of their router with an SSH client

Secure Shell

SSHd	<input checked="" type="radio"/> Enable	<input type="radio"/> Disable
SSH TCP Forwarding	<input type="radio"/> Enable	<input checked="" type="radio"/> Disable
Password Login	<input checked="" type="radio"/> Enable	<input type="radio"/> Disable
Port	<input type="text" value="22"/>	(Default: 22)
Authorized Keys	<input type="text"/>	

SSH TCP Forwarding: enable or disable to support the TCP forwarding

Password Login: allows login with the router password (username is admin)

Port: port number for SSHd (default is 22)

Authorized Keys: here users paste their public keys to enable key-based login (more secure than a simple password)

System log

Enable Syslogd to capture system messages. By default they will be collected in the local file /var/log/messages. To send them to another system, enter the IP address of a remote syslog server.

System Log

Syslogd	<input checked="" type="radio"/> Enable	<input type="radio"/> Disable
Syslog Out Mode	<input checked="" type="radio"/> Net	<input type="radio"/> Console
Remote Server	<input type="text"/>	

Syslog Out Mode: two log mode

Net: the log information output to a syslog server

Console: the log information output to console port

Remote Server: if choose net mode, users should input a syslog server's IP Address and run a syslog server program on it.

Telnet

Telnet

Telnet	<input checked="" type="radio"/> Enable	<input type="radio"/> Disable
--------	---	-------------------------------

Telnet: enable a telnet server to connect to the router with telnet. The username is admin and the password is the router's password.

Note: If users use the router in an untrusted environment (for example as a public hotspot), it is strongly recommended to use SSHd and deactivate telnet.

WAN Traffic Counter

WAN Traffic Counter

ttraff Daemon Enable Disable

Ttraff Daemon: enable or disable wan traffic counter function

3.3.4 VPN

3.3.4.1 PPTP

PPTP Server

PPTP Server

PPTP Server Enable Disable

Broadcast support Enable Disable

Force MPPE Encryption Enable Disable

DNS1

DNS2

WINS1

WINS2

Server IP

Client IP(s)

CHAP-Secrets

Broadcast support: enable or disable broadcast support of PPTP server

Force MPPE Encryption: enable or disable force MPPE encryption of PPTP data

DNS1/DNS2/WINS1/WINS2: set DNS1/DNS2/WINS1/WINS2

Server IP: input IP address of the router as PPTP server, differ from LAN address

Client IP(s): IP address assigns to the client, the format is xxx.xxx.xxx.xxx-xxx

CHAP Secrets: user name and password of the client using PPTP service

Note: client IP must be different with IP assigned by router DHCP.

The format of CHAP Secrets is user * password *.

PPTP Client

PPTP Client

PPTP Client Options	<input checked="" type="radio"/> Enable <input type="radio"/> Disable
Server IP or DNS Name	<input type="text"/>
Remote Subnet	<input type="text" value="0"/> . <input type="text" value="0"/> . <input type="text" value="0"/> . <input type="text" value="0"/>
Remote Subnet Mask	<input type="text" value="0"/> . <input type="text" value="0"/> . <input type="text" value="0"/> . <input type="text" value="0"/>
MPPE Encryption	<input type="text" value="mppe required"/>
MTU	<input type="text" value="1450"/> (Default: 1450)
MRU	<input type="text" value="1450"/> (Default: 1450)
NAT	<input checked="" type="radio"/> Enable <input type="radio"/> Disable
User Name	<input type="text" value="DOMAIN\\Username"/>
Password	<input type="text"/> <input type="checkbox"/> Unmask

Server IP or DNS Name: PPTP server's IP Address or DNS Name

Remote Subnet: the network of the remote PPTP server

Remote Subnet Mask: subnet mask of remote PPTP server

MPPE Encryption: enable or disable Microsoft Point-to-Point Encryption.

MTU: maximum Transmission Unit

MRU: maximum Receive Unit

NAT: network Address Translation

User Name: user name to login PPTP Server.

Password: password to log into PPTP Server.

3.3.4.2 L2TP

L2TP Server

L2TP Server

L2TP Server Options	<input checked="" type="radio"/> Enable <input type="radio"/> Disable
Force MPPE Encryption	<input checked="" type="radio"/> Enable <input type="radio"/> Disable
Server IP	<input type="text"/>
Client IP(s)	<input type="text"/>
CHAP-Secrets	<input type="text"/>

Force MPPE Encryption: enable or disable force MPPE encryption of L2TP data

Server IP: input IP address of the router as PPTP server, differ from LAN address

Client IP(s): IP address assigns to the client, the format is xxx.xxx.xxx.xxx-xxx.xxx.xxx.xxx

CHAP Secrets: user name and password of the client using L2TP service

Note: client IP must be different with IP assigned by router DHCP.
 The format of CHAP Secrets is user * password *.

L2TP Client

L2TP Client

L2TP Client Options Enable Disable

User Name

Password Unmask

Gateway (L2TP Server)

Remote Subnet ...

Remote Subnet Mask ...

MPPE Encryption

MTU (Default: 1450)

MRU (Default: 1450)

NAT Enable Disable

Require CHAP Yes No

Refuse PAP Yes No

Require Authentication Yes No

Gateway(L2TP Server): L2TP server’s IP Address or DNS Name

Remote Subnet: the network of remote PPTP server

Remote Subnet Mask: subnet mask of remote PPTP server

MPPE Encryption: enable or disable Microsoft Point-to-Point Encryption

MTU: maximum transmission unit

MRU: maximum receive unit

NAT: network address translation

User Name: user name to login L2TP Server

Password: password to login L2TP Server

Require CHAP: enable or disable support chap authentication protocol

Refuse PAP: enable or disable refuse to support the pap authentication

Require Authentication: enable or disable support authentication protocol

3.3.5 Security

3.3.5.1 Firewall

You can enable or disable the firewall, filter specific Internet data types, and prevent anonymous Internet requests, ultimately enhance network security.

Firewall Protection

Firewall Protection

SPI Firewall Enable Disable

Firewall enhance network security and use SPI to check the packets into the network. To use firewall protection, choose to enable otherwise disabled. Only enable the SPI firewall, you can use other firewall functions: filtering proxy, block WAN requests, etc.

Additional Filters

Additional Filters

- Filter Proxy
- Filter Cookies
- Filter Java Applets
- Filter ActiveX

Filter Proxy: Wan proxy server may reduce the security of the gateway, Filtering Proxy will refuse any access to any wan proxy server. Click the check box to enable the function otherwise disabled.

Filter Cookies: Cookies are the website of data the data stored on your computer. When you interact with the site, the cookies will be used. Click the check box to enable the function otherwise disabled.

Filter Java Applets: If refuse to Java, you may not be able to open web pages using the Java programming.. Click the check box to enable the function otherwise disabled.

Filter ActiveX: If refuse to ActiveX, you may not be able to open web pages using the ActiveX programming. Click the check box to enable the function otherwise disabled.

Prevent WAN Request

Block WAN Requests

- Block Anonymous WAN Requests (ping)
- Filter IDENT (Port 113)
- Block WAN SNMP access

Block Anonymous WAN Requests (ping): By selecting “Block Anonymous WAN Requests (ping)” box to enable this feature, you can prevent your network from the Ping or detection of other Internet users. so that make More difficult to break into your network. The default state of this feature is enabled, choose to disable allow anonymous Internet requests.

Filter IDENT (Port 113): Enable this feature can prevent port 113 from being scanned from outside. Click the check box to enable the function otherwise disabled.

Block WAN SNMP access: This feature prevents the SNMP connection requests from the WAN.

After Complete the changes, click the **Save Settings** button to save your changes. Click the **Cancel Changes** button to cancel unsaved changes.

Impede WAN DoS/Bruteforce

Impede WAN DoS/Bruteforce

Limit SSH Access

Limit Telnet Access

Limit PPTP Server Access

Limit L2TP Server Access

Limit ssh Access: This feature limits the access request from the WAN by ssh, and per minute up to accept two connection requests on the same IP. Any new access request will be automatically dropped.

Limit Telnet Access: This feature limits the access request from the WAN by Telnet, and per minute up to accept two connection requests on the same IP. Any new access request will be automatically dropped.

Limit PPTP Server Access: When build a PPTP Server in the router, this feature limits the access request from the WAN by ssh, and per minute up to accept two connection requests on the same IP . Any new access request will be automatically dropped.

Limit L2TP Server Access: When build a L2TP Server in the router, this feature limits the access request from the WAN by ssh, and per minute up to accept two connection requests on the same IP. Any new access request will be automatically dropped.

Log Management

The router can keep logs of all incoming or outgoing traffic for your Internet connection.

Log

Log Enable Disable

Log: To keep activity logs, select Enable. To stop logging, select Disable. When select enable, the following page will appear.

Log

Log Enable Disable

Log Level

Options

Dropped

Rejected

Accepted

Log Level: Set this to the required log level. Set Log Level higher to log more actions.

Options: When select Enable, the corresponding connection will be recorded in the journal, the disabled are not recorded.

Incoming Log: To see a temporary log of the Router's most recent incoming traffic, click the Incoming Log button.

Incoming Log Table			
Source IP	Protocol	Destination Port Number	Rule
<input type="button" value="Refresh"/> <input type="button" value="Close"/>			

Outgoing Log: To see a temporary log of the Router's most recent outgoing traffic, click the Outgoing Log button.

Outgoing Log Table				
LAN IP	Destination URL/IP	Protocol	Service/Port Number	Rule
192.168.1.164	223.203.188.56	TCP	www	Accepted
192.168.1.164	183.60.16.200	UDP	8000	Accepted
192.168.1.164	183.60.48.60	UDP	8000	Accepted
192.168.1.164	112.95.240.183	UDP	8000	Accepted
192.168.1.164	183.60.49.245	UDP	8000	Accepted
192.168.1.164	119.147.32.204	UDP	8000	Accepted
192.168.1.164	112.90.86.244	UDP	8000	Accepted
192.168.1.164	119.147.45.157	UDP	8000	Accepted
192.168.1.164	183.60.49.15	UDP	8000	Accepted
192.168.1.164	183.60.16.70	UDP	8000	Accepted
192.168.1.164	183.60.16.200	UDP	8000	Accepted
192.168.1.164	183.60.48.60	UDP	8000	Accepted

Click the **Save Settings** button to save your changes. Click the **Cancel Changes** button to cancel unsaved changes.

3.3.5.2 VPN Passthrough

Virtual Private Networking (VPN) is typically used for work-related networking. For VPN tunnels, the router supports OPENVPN Passthrough, PPTP Passthrough and L2TP Passthrough.

Virtual Private Network (VPN)	
VPN Passthrough	
IPSec Passthrough	<input checked="" type="radio"/> Enable <input type="radio"/> Disable
PPTP Passthrough	<input checked="" type="radio"/> Enable <input type="radio"/> Disable
L2TP Passthrough	<input checked="" type="radio"/> Enable <input type="radio"/> Disable

IPSec Passthrough:Internet Protocol Security (IPSec) is a suite of protocols used to implement secure exchange of packets at the IP layer. To allow IPSec tunnels to pass through the router, IPSec Passthrough is enabled by default. To disable IPSec Passthrough, select Disable.

PPTP Passthrough:Point-to-Point Tunneling Protocol is the method used to enable VPN sessions to a Windows NT 4.0 or 2000 server. To allow PPTP tunnels to pass through the router, PPTP Passthrough is enabled by default. To disable PPTP Passthrough, select Disable.

L2TP Passthrough:Layer Two (2) Tunneling Protocol, an extension to the PPP protocol that enables ISPs to operate Virtual Private Networks (VPNs). L2TP merges the best features of two other tunneling protocols: PPTP from Microsoft and L2F from Cisco

Systems. To allow L2TP tunnels to pass through the router, L2TP Passthrough is enabled by default. To disable L2TP Passthrough, select Disable.

Click the **Save Settings** button to save your changes. Click the **Cancel Changes** button to cancel unsaved changes.

3.3.6 Access Restrictions

3.3.6.1 WAN Access

Use access restrictions, you can block or allow specific types of Internet applications. You can set specific PC-based Internet access policies. This feature allows you to customize up to ten different Internet Access Policies for particular PCs, which are identified by their IP or MAC addresses.

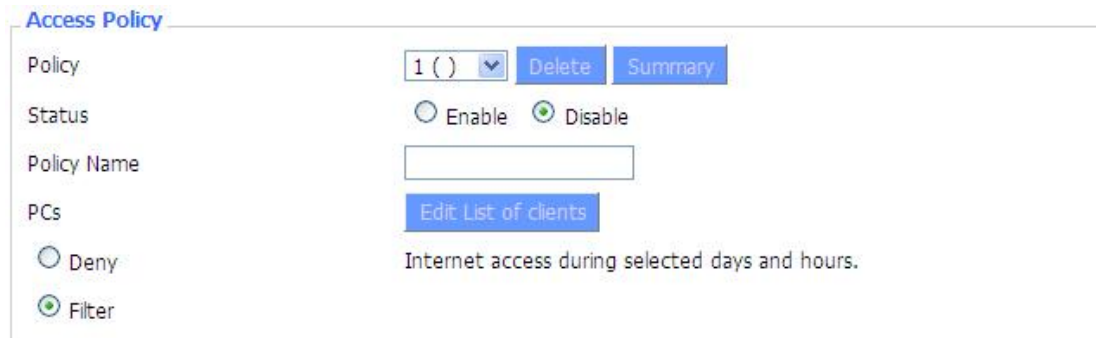

Two options in the default policy rules: "Filter" and "reject". If select "Deny", you will deny specific computers to access any Internet service at a particular time period. If you choose to "filter", It will block specific computers to access the specific sites at a specific time period. You can set up 10 Internet access policies filtering specific PCs access Internet services at a particular time period.

Access Policy: You may define up to 10 access policies. Click Delete to delete a policy or Summary to see a summary of the policy.

Status: Enable or disable a policy.

Policy Name: You may assign a name to your policy.

PCs: The part is used to edit client list, the strategy is only effective for the PC in the list.

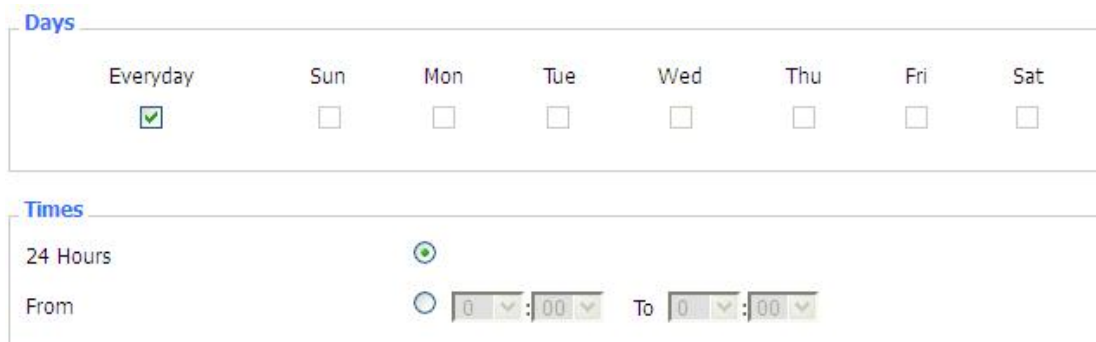

Days: Choose the day of the week you would like your policy to be applied.

Times: Enter the time of the day you would like your policy to be applied.

Website Blocking by URL Address

<input type="text"/>	<input type="text"/>	<input type="text"/>
<input type="text"/>	<input type="text"/>	<input type="text"/>
<input type="text"/>	<input type="text"/>	<input type="text"/>

Website Blocking by Keyword

<input type="text"/>	<input type="text"/>	<input type="text"/>	<input type="text"/>
<input type="text"/>	<input type="text"/>	<input type="text"/>	<input type="text"/>

Website Blocking by URL Address: You can block access to certain websites by entering their URL.

Website Blocking by Keyword: You can block access to certain website by the keywords contained in their webpage

List of clients	
Enter MAC Address of the clients in this format: xx:xx:xx:xx:xx:xx	
MAC 01	<input type="text" value="00:AA:BB:CC:DD:EE"/>
MAC 02	<input type="text" value="00:00:00:00:00:00"/>
MAC 03	<input type="text" value="00:00:00:00:00:00"/>
MAC 04	<input type="text" value="00:00:00:00:00:00"/>
MAC 05	<input type="text" value="00:00:00:00:00:00"/>
MAC 06	<input type="text" value="00:00:00:00:00:00"/>
MAC 07	<input type="text" value="00:00:00:00:00:00"/>
MAC 08	<input type="text" value="00:00:00:00:00:00"/>
Enter the IP Address of the clients	
IP 01	192.168.1. <input type="text" value="15"/>
IP 02	192.168.1. <input type="text" value="0"/>
IP 03	192.168.1. <input type="text" value="0"/>
IP 04	192.168.1. <input type="text" value="0"/>
IP 05	192.168.1. <input type="text" value="0"/>
IP 06	192.168.1. <input type="text" value="0"/>
Enter the IP Range of the clients	
IP Range 01	<input type="text" value="192"/> . <input type="text" value="168"/> . <input type="text" value="1"/> . <input type="text" value="19"/> ~ <input type="text" value="192"/> <input type="text" value="168"/> <input type="text" value="1"/> <input type="text" value="30"/>
IP Range 02	<input type="text" value="0"/> . <input type="text" value="0"/> . <input type="text" value="0"/> . <input type="text" value="0"/> ~ <input type="text" value="0"/> <input type="text" value="0"/> <input type="text" value="0"/> <input type="text" value="0"/>

Set up Internet Access Policy

1. Select the policy number (1-10) in the drop-down menu.
2. For this policy is enabled, click the radio button next to "Enable"
3. Enter a name in the Policy Name field.
4. Click the Edit List of PCs button.
5. On the List of PCs screen, specify PCs by IP address or MAC address. Enter the appropriate IP addresses into the IP fields. If you have a range of IP addresses to filter, complete the appropriate IP Range fields. Enter the appropriate MAC addresses into the MAC fields.
6. Click the Apply button to save your changes. Click the Cancel button to cancel your unsaved changes. Click the Close button to return to the Filters screen.
7. If you want to block the listed PCs from Internet access during the designated days and time, then keep the default setting, Deny. If you want the listed PCs to have Internet filtered during the designated days and time, then click the radio button next to Filter.
8. Set the days when access will be filtered. Select Everyday or the appropriate days of the week.
9. Set the time when access will be filtered. Select 24 Hours, or check the box next to From and use the drop-down boxes to designate a specific time period.
10. Click the Add to Policy button to save your changes and active it.
11. To create or edit additional policies, repeat steps 1-9.
12. To delete an Internet Access Policy, select the policy number, and click the Delete button.

Note:

- 1) The default factory value of policy rules is "filtered". If the user chooses the default policy rules for "refuse", and editing strategies to save or directly to save the settings. If the strategy edited is the first, it will be automatically saved into the second, if not the first, keep the original number.
- 2) Turn off the power of the router or reboot the router can cause a temporary failure. After the failure of the router, if can not automatically synchronized NTP time server, you need to recalibrate to ensure the correct implementation of the relevant period control function.

3.3.6.2 URL Filter

If you want to prevent certain client access to specific network domain name, such as www.sina.com. We can achieved it through the function of URL filter.

URL filtering function

Url Filter

Url Filter Setting

Enable Url Filter Enable Disable

Policy Discard packets conform to the following rules

Del	Num	URL
<input type="checkbox"/>	1	<i>www.sina.com</i>

Add Filter Rule

Type URL

Add

Discard packets conform to the following rules: only discard the matching URL address in the list .

Accept only the data packets conform to the following rules: receive only with custom rules of network address, discarded all other URL address.

3.3.6.3 Packet Filter

To block some packets getting Internet access or block some Internet packets getting local network access, you can configure filter items to block these packets.

Packet Filter

Packet filter function is realized based on IP address or port of packets.

Enable Packet Filter Enable Disable

Policy Discard packets conform to the following rules

Enable Packet Filter: Enable or disable “packet filter” function

Policy: The filter rule’s policy, you can choose the following options

Discard The Following--Discard packets conform to the following rules, Accept all other packets

Only Accept The Following-- Accept only the data packets conform to the following rules, Discard all other packets

Add Filter Rule

Direction: OUTPUT

Protocol: TCP/UDP

Source Ports: 1 - 65535

Destination Ports: 1 - 65535

Source IP: 0.0.0.0/0

Destination IP: 0.0.0.0/0

Add

Direction

- input:** packet from WAN to LAN
- output:** packet from LAN to WAN

Protocol: packet protocol type

Source Ports: packet's source port

Destination Ports: packet's destination port

Source IP: packet's source IP address

Destination IP: packet's destination IP address

Note: "Source Port" ,"Destination Port" ,"Source IP" ,"Destination IP" could not be all empty ,you have to input at least one of these four parameters.

3.3.7 NAT

3.3.7.1 Port Forwarding

Port Forwarding allows you to set up public services on your network, such as web servers, ftp servers, e-mail servers, or other specialized Internet applications. Specialized Internet applications are any applications that use Internet access to perform functions such as videoconferencing or online gaming. When users send this type of request to your network via the Internet, the router will forward those requests to the appropriate PC. If you want to forward a whole range of ports, see [Port Range Forwarding](#).

Forwards

Application	Protocol	Source Net	Port from	IP Address	Port to	Enable
web	TCP	192.168.8.11	8000	192.168.1.12	80	<input checked="" type="checkbox"/>
ftp	Both	192.168.8.12	24	192.168.1.12	21	<input checked="" type="checkbox"/>

Add Remove

Application: Enter the name of the application in the field provided.

Protocol: Chose the right protocol TCP,UDP or Both. Set this to what the application requires.

Source Net: Forward only if sender matches this ip/net (example 192.168.1.0/24).

Port from: Enter the number of the external port (the port number seen by users on the Internet).

IP Address: Enter the IP Address of the PC running the application.

Port to: Enter the number of the internal port (the port number used by the application).

Enable: Click the Enable checkbox to enable port forwarding for the application.

Check all values and click **Save Settings** to save your settings. Click the **Cancel changes** button to cancel your unsaved changes.

3.3.7.2 Port Range Forward

Port Range Forwarding allows you to set up public services on your network, such as web servers, ftp servers, e-mail servers, or other specialized Internet applications. Specialized Internet applications are any applications that use Internet access to perform functions such as videoconferencing or online gaming. When users send this type of request to your network via the Internet, the router will forward those requests to the appropriate PC. If you only want to forward a single port, see [Port Forwarding](#).

Port Range Forward

Forwards

Application	Start	End	Protocol	IP Address	Enable
web-tftp	800	8100	Both ▼	192.168.1.16	<input checked="" type="checkbox"/>
game	9000	10000	Both ▼	192.168.1.16	<input checked="" type="checkbox"/>

Application: Enter the name of the application in the field provided.

Start:Enter the number of the first port of the range you want to seen by users on the Internet and forwarded to your PC.

End: Enter the number of the last port of the range you want to seen by users on the Internet and forwarded to your PC.

Protocol: Chose the right protocol TCP,UDP or Both. Set this to what the application requires.

IP Address: Enter the IP Address of the PC running the application.

Enable: Click the Enable checkbox to enable port forwarding for the application.

Check all values and click **Save Settings** to save your settings. Click the **Cancel changes** button to cancel your unsaved changes.

3.3.7.3 DMZ

The DMZ (DeMilitarized Zone) hosting feature allows one local user to be exposed to

the Internet for use of a special-purpose service such as Internet gaming or videoconferencing. DMZ hosting forwards all the ports at the same time to one PC. The Port Forwarding feature is more secure because it only opens the ports you want to have opened, while DMZ hosting opens all the ports of one computer, exposing the computer so the Internet can see it.

Demilitarized Zone (DMZ)



DMZ

Use DMZ Enable Disable

DMZ Host IP Address 192.168.8.

Any PC whose port is being forwarded must should have a new static IP address assigned to it because its IP address may change when using the DHCP function.

DMZ Host IP Address: To expose one PC to the Internet, select Enable and enter the computer's IP address in the DMZ Host IP Address field. To disable the DMZ, keep the default setting:Disable

Check all values and click **Save Settings** to save your settings. Click the **Cancel changes** button to cancel your unsaved changes.

3.3.8 QoS Setting

3.3.8.1 Basic

Bandwidth management prioritizes the traffic on your router. Interactive traffic (telephony, browsing, telnet, etc.) gets priority and bulk traffic (file transfer, P2P) gets low priority. The main goal is to allow both types to live side-by side without unimportant traffic disturbing more critical things. All of this is more or less automatic.

QoS allows control of the bandwidth allocation to different services, netmasks, MAC addresses and the four LAN ports.

Main WAN QoS Settings

Start QoS Enable Disable

Port WAN

Packet Scheduler HTB

Uplink (kbps) 0

Downlink (kbps) 0

Bkup WAN QoS Settings

Start QoS Enable Disable

Port WAN

Packet Scheduler HTB

Uplink (kbps) 0

Downlink (kbps) 0

Uplink (kbps):In order to use bandwidth management (QoS) you must enter bandwidth values for your uplink. These are generally 80% to 90% of your maximum bandwidth.

Downlink (kbps):In order to use bandwidth management (QoS) you must enter bandwidth values for your downlink. These are generally 80% to 90% of your maximum bandwidth.

3.3.8.2 Classify

Netmask Priority

Netmask Priority

Delete	IP/Mask	Priority
<input type="checkbox"/>	192.168.1.1/24	Exempt ▼
<input type="checkbox"/>	192.168.2.3/24	Standard ▼
<input type="checkbox"/>	192.168.3.4/32	Express ▼
<input type="checkbox"/>	192.168.4.5/32	Bulk ▼
Add	<input style="width: 30px;" type="text" value="0"/> . <input style="width: 30px;" type="text" value="0"/> . <input style="width: 30px;" type="text" value="0"/> . <input style="width: 30px;" type="text" value="0"/> / <input style="width: 30px;" type="text" value="0"/>	

You may specify priority for all traffic from a given IP address or IP Range.

Check all values and click **Save Settings** to save your settings. Click the **Cancel changes** button to cancel your unsaved changes.

3.3.9 Applications

3.3.9.1 Serial Applications

There is a console port on router. Normally, this port is used to debug the router. This port can also be used as a serial port. The router has embedded a serial to TCP program. The data sent to the serial port is encapsulated by TCP/IP protocol stack and then is sent to the destination server. This function can work as a DTU (Data Terminal Unit). Please refer www.four-faith.com for more information about this product.

Serial Applications

Serial Applications Enable Disable

Baudrate

Databit

Stopbit

Parity

Flow Control

Protocol

Server Address

Server Port

Device Number

Device Id

Heartbeat Interval

Baudrate: The serial port's baudrate

Databit: The serial port's databit

Parity: The serial port's parity

Stopbit: The serial port's stopbit

Flow Control: The serial port's flow control type.

Enable Serial TCP Function: Enable the serial to TCP function

Protocol Type: The protocol type to transmit data.

UDP(DTU) - Data transmit with UDP protocol, work as a DTU which has application protocol and hear beat mechanism.

Pure UDP - Data transmit with standard UDP protocol.

TCP(DTU) - Data transmit with TCP protocol, work as a DTU which has application protocol and hear beat mechanism.

Pure TCP - Data transmit with standard TCP protocol, router is the client.

TCP Server - Data transmit with standard TCP protocol, router is the server.

TCST -- Data transmit with TCP protocol, Using a custom data

Server Address: The data service center's IP Address or domain name.

Server Port: The data service center's listening port.

Device ID: The router's identity ID.

Device Number: The router's phone number.

Heartbeat Interval: The time interval to send heart beat packet. This item is valid only when you choose UDP(DTU) or TCP(DTU) protocol type.

TCP Server Listen Port: This item is valid when Protocol Type is "TCP Server"

Custom Heartbeat Packet : This item is valid when Protocol Type is "TCST"

Custom Registration Packets: This item is valid when Protocol Type is "TCST"

3.3.10 Administration

3.3.10.1 Management

The Management screen allows you to change the router's settings. On this page you will find most of the configurable items of the router code.

Router Password

Router Username	<input type="password" value="....."/>
Router Password	<input type="password" value="....."/>
Re-enter to confirm	<input type="password" value="....."/>

The new password must not exceed 32 characters in length and must not include any spaces. Enter the new password a second time to confirm it.

Note:

Default username is admin.

It is strongly recommended that you change the factory default password of the router, which is admin. All users who try to access the router's web-based utility or Setup Wizard will be prompted for the router's password.

Web Access

This feature allows you to manage the router using either HTTP protocol or the HTTPS protocol. If you choose to disable this feature, a manual reboot will be required. You can also activate or not the router information web page. It's now possible to password protect this page (same username and password than above).

Web Access

Protocol	<input checked="" type="checkbox"/> HTTP <input type="checkbox"/> HTTPS
Auto-Refresh (in seconds)	<input type="text" value="3"/>
Enable Info Site	<input checked="" type="radio"/> Enable <input type="radio"/> Disable
Info Site Password Protection	<input type="checkbox"/> Enabled

Protocol:This feature allows you to manage the router using either HTTP protocol or the HTTPS protocol

Auto-Refresh:Adjusts the Web GUI automatic refresh interval. 0 disables this feature completely

Enable Info Site:Enable or disable the login system information page

Info Site Password Protection:Enable or disable the password protection feature of the system information page

Remote Access

Web GUI Management	<input checked="" type="radio"/> Enable <input type="radio"/> Disable	
Use HTTPS	<input type="checkbox"/>	
Web GUI Port	<input type="text" value="8080"/>	(Default: 8080, Range: 1 - 65535)
SSH Management	<input checked="" type="radio"/> Enable <input type="radio"/> Disable	
SSH Remote Port	<input type="text" value="22"/>	(Default: 22, Range: 1 - 65535)
Telnet Management	<input type="radio"/> Enable <input checked="" type="radio"/> Disable	

Remote Access:This feature allows you to manage the router from a remote location, via the Internet. To disable this feature, keep the default setting, Disable. To enable this feature, select Enable, and use the specified port (default is 8080) on your PC to remotely manage the router. You must also change the router's default password to one of your own, if you haven't already.

To remotely manage the router, enter `http://xxx.xxx.xxx.xxx:8080` (the x's represent the router's Internet IP address, and 8080 represents the specified port) in your web browser's address field. You will be asked for the router's password.

If you use https you need to specify the url as `https://xxx.xxx.xxx.xxx:8080` (not all firmwares does support this without rebuilding with SSL support).

SSH Management:You can also enable SSH to remotely access the router by Secure Shell. Note that SSH daemon needs to be enable in Services page.

Note:

If the Remote Router Access feature is enabled, anyone who knows the router's Internet IP address and password will be able to alter the router's settings.

Telnet Management:Enable or disable remote Telnet function

Cron

Cron	<input checked="" type="radio"/> Enable <input type="radio"/> Disable
Additional Cron Jobs	<input type="text"/>

Cron:The cron subsystem schedules execution of Linux commands. You'll need to use the command line or startup scripts to actually use this.

Language Selection

Language	<input type="text" value="English"/>
----------	--------------------------------------

Language: Set up the router page shows the type of language, including simplified Chinese and English.

Device Management

Device Management Enable Disable

Device Management Server IP

Device Management Server Listen Port (Default: 40001, Range: 1 - 65535)

Heart Interval (Default: 60Sec, Range: 1 - 999)

Device Number

Device Phone Number

Device Type Description

Remote Upgrade: custom-developed remote management server for this station router monitoring and management, configuration parameters, WIFI advertising updates.

3.3.10.2 Keep Alive

Schedule Boot&Shutdown

Schedule Boot&Shutdown

Schedule Boot&Shutdown Enable Disable

Match Day Weekday Days Weekdays

Shutdown Time :

Shutdown Date - - -

Boot Time :

Boot Date - - -

The user can set the startup or shutdown time:

For example, the user wants to set the start time at 8:07 and boot time at 9:07.

Schedule Boot&Shutdown

Schedule Boot&Shutdown Enable Disable

Match Day Weekday Days Weekdays

Shutdown Time :

Shutdown Date - - -

Boot Time :

Boot Date - - -

Schedule Reboot

Schedule Reboot

Schedule Reboot	<input checked="" type="radio"/> Enable <input type="radio"/> Disable
Interval (in seconds)	<input checked="" type="radio"/> <input type="text" value="3600"/>
At a set Time	<input type="radio"/> <input type="text" value="00"/> : <input type="text" value="00"/> <input type="text" value="Sunday"/>

You can schedule regular reboots for the router :

Regularly after xxx seconds.

At a specific date time each week or everyday.

Note:

For date based reboots Cron must be activated. See Management for Cron activation.

3.3.10.3 Commands

Commands:You are able to run command lines directly via the Webinterface.

Command Shell

Commands

Run CommandsSave StartupSave ShutdownSave FirewallSave Custom Script

Run Command:You can run command lines via the web interface. Fill the text area with your command and click Run Commands to submit.

Startup:You can save some command lines to be executed at startup's router. Fill the text area with commands (only one command by row) and click Save Startup.

Shutdown:You can save some command lines to be executed at shutdown's router. Fill the text area with commands (only one command by row) and click Save Shutdown.

Firewall:Each time the firewall is started, it can run some custom iptables instructions. Fill the text area with firewall's instructions (only one command by row) and click Save Firewall.

Custom Script:Custom script is stored in /tmp/custom.sh file. You can run it manually or use cron to call it. Fill the text area with script's instructions (only one command by row) and click Save Custom Script.

3.3.10.4 Factory Defaults

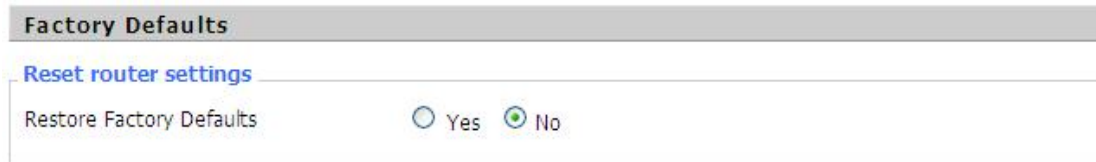

Reset router settings:Click the Yes button to reset all configuration settings to their default values. Then click the Apply Settings button.

Note:

Any settings you have saved will be lost when the default settings are restored. After restoring the router is accessible under the default IP address 192.168.1.1 and the default password admin.

3.3.10.5 Firmware Upgrade



Firmware Upgrade:New firmware versions are posted at www.four-faith.com and can be downloaded. If the Router is not experiencing difficulties, then there is no need to download a more recent firmware version, unless that version has a new feature that you want to use.

Note:

When you upgrade the Router's firmware, you lose its configuration settings, so make sure you write down the Router settings before you upgrade its firmware.

To upgrade the Router's firmware:

1. Download the firmware upgrade file from the website.
2. Click the Browse... button and chose the firmware upgrade file.
3. Click the Upgrade button and wait until the upgrade is finished.

Note:

Upgrading firmware may take a few minutes.

Do not turn off the power or press the reset button!

After flashing, reset to:If you want to reset the router to the default settings for the firmware version you are upgrading to, click the Firmware Defaults option.

3.3.10.6 Backup

Backup Configuration

Backup Settings

Click the "Backup" button to download the configuration backup file to your computer.

Restore Configuration

Restore Settings

Please select a file to restore

WARNING

Only upload files backed up using this firmware and from the same model of router.
Do not upload any files that were not created by this interface!

Backup Settings:You may backup your current configuration in case you need to reset the router back to its factory default settings.Click the Backup button to backup your current configuration.

Restore Settings:Click the Browse... button to browse for a configuration file that is currently saved on your PC.Click the Restore button to overwrite all current configurations with the ones in the configuration file.

Note:

Only restore configurations with files backed up using the same firmware and the same model of router.

3.3.11 Status

3.3.11.1 Router

System	
Router Name	Four-Faith
Router Model	Four-Faith Router
Firmware Version	FXXXX v1.0 (01/10/12) std - build 94
MAC Address	<u>00:AA:BB:CC:DD:44</u>
Host Name	
WAN Domain Name	
LAN Domain Name	
Current Time	Sat, 01 Jan 2000 00:51:29
Uptime	51 min,

Router Name: name of the router, setting→basic setting to modify

Router Model: model of the router, unavailable to modify

Firmware Version: software version information

MAC Address: MAC address of WAN, setting→Clone MAC Address to modify

Host Name: host name of the router, setting→basic setting to modify

WAN Domain Name: domain name of WAN, setting→basic setting to modify

LAN Domain Name: domain name of LAN, unavailable to modify

Current Time: local time of the system

Uptime: operating uptime as long as the system is powered on

Memory



Total Available: the room for total available of RAM (that is physical memory minus some reserve and the kernel of binary code bytes)

Free: free memory, the router will reboot if the memory is less than 500kB

Used: used memory, total available memory minus free memory

Buffers: used memory for buffers,

Cached: the memory used by high-speed cache memory

Active: active use of buffer or cache memory page file size

Inactive: not often used in a buffer or cache memory page file size

Network

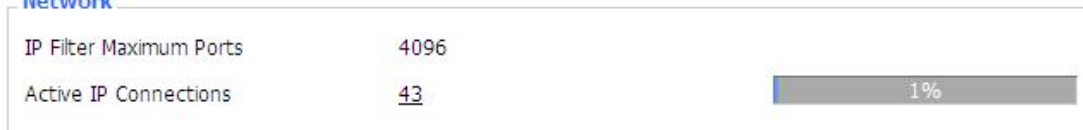

IP Filter Maximum Ports: preset is 4096, available to re-management

Active IP Connections: real time monitor active IP connections of the system, click to see the table as blow:

No.	Protocol	Timeout (s)	Source Address	Remote Address	Service Name	State
1	TCP	60	192.168.1.120	192.168.1.1	80	TIME_WAIT
2	TCP	30	192.168.1.120	192.168.1.1	80	TIME_WAIT
3	TCP	65	192.168.1.120	192.168.1.1	80	TIME_WAIT
4	TCP	96	192.168.1.120	192.168.1.1	80	TIME_WAIT
5	TCP	99	192.168.1.120	192.168.1.1	80	TIME_WAIT
6	TCP	70	192.168.1.120	192.168.1.1	80	TIME_WAIT
7	TCP	74	192.168.1.120	192.168.1.1	80	TIME_WAIT
8	TCP	115	192.168.1.120	192.168.1.1	80	TIME_WAIT
9	TCP	84	192.168.1.120	192.168.1.1	80	TIME_WAIT
10	TCP	3599	192.168.1.120	192.168.1.1	80	ESTABLISHED
11	TCP	3599	192.168.1.120	192.168.1.1	80	ESTABLISHED
12	TCP	108	192.168.1.120	192.168.1.1	80	TIME_WAIT
13	TCP	3600	192.168.1.120	192.168.1.1	80	ESTABLISHED
14	TCP	93	192.168.1.120	192.168.1.1	80	TIME_WAIT
15	TCP	102	192.168.1.120	192.168.1.1	80	TIME_WAIT
16	TCP	74	192.168.1.120	192.168.1.1	80	TIME_WAIT
17	TCP	3599	192.168.1.120	192.168.1.1	80	ESTABLISHED
18	TCP	15	192.168.1.120	192.168.1.1	80	TIME_WAIT
19	TCP	25	192.168.1.120	192.168.1.1	80	TIME_WAIT
20	TCP	90	192.168.1.120	192.168.1.1	80	TIME_WAIT
21	UDP	26	192.168.8.119	255.255.255.255	1947	UNREPLIED
22	TCP	77	192.168.1.120	192.168.1.1	80	TIME_WAIT
23	TCP	35	192.168.1.120	192.168.1.1	80	TIME_WAIT
24	TCP	74	192.168.1.120	192.168.1.1	80	TIME_WAIT
25	TCP	40	192.168.1.120	192.168.1.1	80	TIME_WAIT
26	TCP	3599	192.168.1.120	192.168.1.1	80	ESTABLISHED
27	TCP	74	192.168.1.120	192.168.1.1	80	TIME_WAIT
28	TCP	74	192.168.1.120	192.168.1.1	80	TIME_WAIT
29	TCP	4	192.168.1.120	192.168.1.1	80	TIME_WAIT
30	UDP	31	192.168.8.160	224.0.0.1	9166	UNREPLIED
31	TCP	74	192.168.1.120	192.168.1.1	80	TIME_WAIT

Active IP Connections: total active IP connections

Protocol: connection protocol

Timeouts: connection timeouts, unit is second

Source Address: source IP address

Remote Address: remote IP address

Service Name: connecting service port

Status: displayed status

3.3.11.2 WAN

Connection Type Automatic Configuration - DHCP

Connection Uptime Not available

Connection Type: disabled, static IP, automatic configuration-DHCP, PPPOE, PPTP, L2TP, 3G/UMTS

Connection Uptime: connecting uptime; If disconnect, display Not available

IP Address 0.0.0.0
Subnet Mask 0.0.0.0
Gateway 0.0.0.0
DNS 1
DNS 2
DNS 3

IP Address: IP address of router WAN

Subnet Mask: subnet mask of router WAN

Gateway: the gateway of router WAN

DNS1, DNS2, DNS3: DNS1/DNS2/DNS3 of router WAN

Remaining Lease Time 0 days 23:38:43

DHCP Release

DHCP Renew

Remaining Lease Time: remaining lease time of IP address in DHCP way

DHCP Release: release DHCP address

DHCP Renew: renew IP address in DHCP way, default is 1 day

Login Status

Disconnected

Connect

Login Status: connection status of WAN

Disconnection: disconnect

Connection: connect

Module Type

ZTE-EVDO MODULE



Signal Status

-79 dBm

Network

CDMA/HDR

Module Type: module type in 3G/UMTS way

Signal Status: signal intensity of the module in 3G/UMTS way

Network: network type of the module in 3G/UMTS way

Total Traffic

Incoming (MBytes)	0
Outgoing (MBytes)	0

Traffic by Month

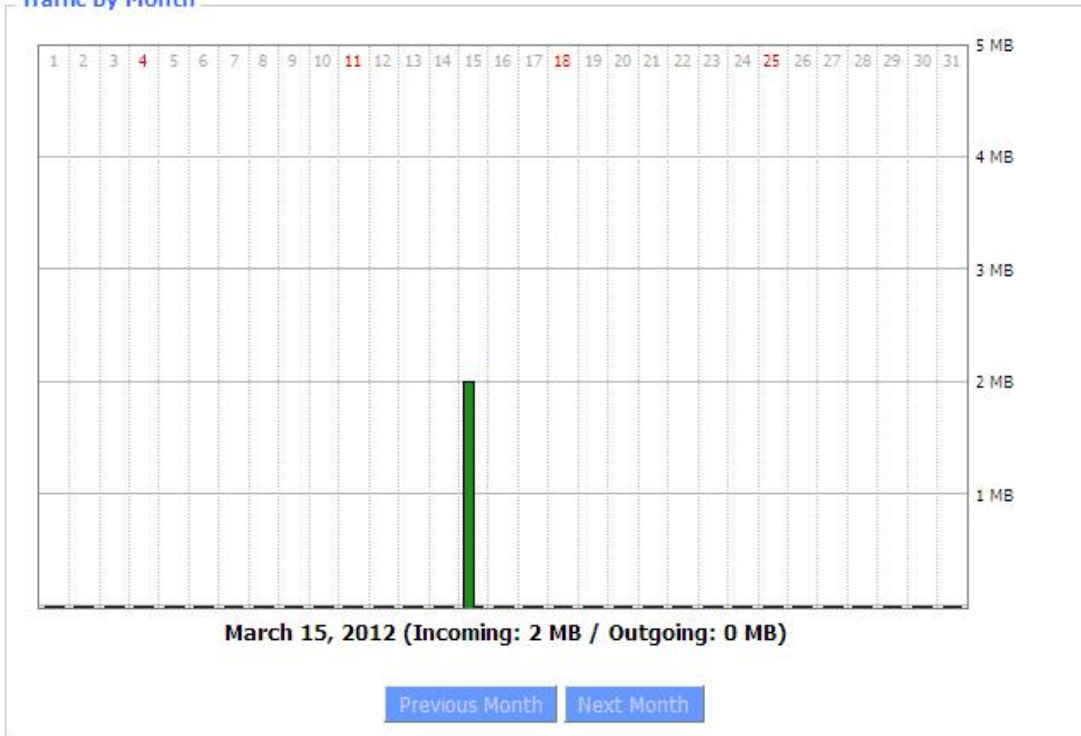

Total Flow: flow from power-off last time until now statistics, download and upload direction

Monthly Flow: the flow of a month, unit is MB

Last Month: the flow of last month

Next Month: the flow of next month

Data Administration

Backup
Restore
Delete

Backup: backup data administration

Restore: restore data administration

Delete: delete data administration

3.3.11.3 LAN

LAN Status

MAC Address	<u>00:0C:43:30:52:77</u>
IP Address	192.168.1.1
Subnet Mask	255.255.255.0
Gateway	0.0.0.0
Local DNS	0.0.0.0

MAC Address: MAC Address of the LAN port ethernet

IP Address: IP Address of the LAN port

Subnet Mask: Subnet Mask of the LAN port

Gateway: Gateway of the LAN port

Local DNS: DNS of the LAN port

Active Clients

Host Name	IP Address	MAC Address	Conn. Count	Ratio [4096]
*	192.168.1.120	<u>10:78:D2:98:C9:46</u>	57	1%

Host Name: host name of LAN client

IP Address: IP address of the client

MAC Address: MAC address of the client

Conn. Count: connection count caused by the client

Ratio: the ratio of 4096 connection

Dynamic Host Configuration Protocol

DHCP Status

DHCP Server	Enabled
DHCP Daemon	uDHCpd
Start IP Address	192.168.1.100
End IP Address	192.168.1.149
Client Lease Time	1440 minutes

DHCP Server: enable or disable the router work as a DHCP server



DHCP Daemon: the agreement allocated using DHCP including DNSMasq and uDHCpd

Starting IP Address: the starting IP Address of the DHCP server's Address pool

Ending IP Address: the ending IP Address of the DHCP server's Address pool

Client Lease Time: the lease time of DHCP client

DHCP Clients

Host Name	IP Address	MAC Address	Client Lease Time	Delete
PC-201011161332	192.168.1.142	<u>00:21:5C:33:4D:29</u>	1 day 00:00:00	
jack-lincw	192.168.1.117	<u>44:37:E6:3F:45:54</u>	1 day 00:00:00	
*	192.168.1.149	<u>00:0C:E7:00:00:00</u>	1 day 00:00:00	

Host Name: host name of LAN client

IP Address: IP address of the client

MAC Address: MAC address of the client

Expires: the expiry the client rents the IP address

Delete: click to delete DHCP client

Connected PPPOE Clients

Interface	User Name	Local IP	Delete
ppp0	hometest	192.168.10.10	

Interface: the interface assigned by dial-up system

User Name: user name of PPPoE client

Local IP: IP address assigned by PPPoE client

Delete: click to delete PPPoE client

Connected L2TP Server

Interface	Local IP	Remote IP	Delete
ppp0	172.168.8.2	172.168.8.1	

Interface: the interface assigned by dial-up system

Local IP: tunnel IP address of local L2TP

Remote IP: tunnel IP address of L2TP server

Delete: click to disconnect L2TP

Connected L2TP Clients

Interface	User Name	Local IP	Remote IP	Delete
ppp1	hometest	192.168.50.2	120.42.46.98	

Interface: the interface assigned by dial-up system

User Name: user name of the client

Local IP: tunnel IP address of L2TP client

Remote IP: IP address of L2TP client

Delete: click to delete L2TP client

Connected PPTP Server

Interface	Local IP	Remote IP	Delete
ppp0	172.168.8.2	172.168.8.1	

Interface: the interface assigned by dial-up system

Local IP: tunnel IP address of local PPTP

Remote IP: tunnel IP address of PPTP server

Delete: click to disconnect PPTP

Connected PPTP Clients

Interface	User Name	Local IP	Remote IP	Delete
ppp1	hometest	192.168.5.1	120.42.46.98	

Interface: the interface assigned by dial-up system

User Name: user name of the client

Local IP: tunnel IP address of PPTP client

Remote IP: IP address of PPTP client

Delete: click to delete PPTP client

3.3.11.4 Wireless

Wireless Status

MAC Address	00:0C:43:30:52:79
Radio	Radio is On
Mode	AP
Network	Mixed
SSID	four-faith
Channel	6 (2437 MHz)
TX Power	71 mW
Rate	72 Mb/s
Encryption - Interface w10	Disabled
PPTP Status	Disconnected

MAC Address: MAC address of wireless client

Radio: display whether radio is on or not

Mode: wireless mode

Network: wireless network mode

SSID: wireless network name

Channel: wireless network channel

TX Power: reflection power of wireless network

Rate: reflection rate of wireless network

Encryption-Interface w10: enable or diasbal Encryption-Interface w10

PPTP Status: show wireless pptp status

Wireless Packet Info

Received (RX)	91125 OK, no error	100%
Transmitted (TX)	11957 OK, no error	100%

Received (RX): received data packet

Transmitted (TX): transmitted data packet

Wireless Nodes

Clients

MAC Address	Interface	Uptime	TX Rate	RX Rate	Signal	Noise	SNR	Signal Quality
- None -								

- MAC Address:** MAC address of wireless client
- Interface:** interface of wireless client
- Uptime:** connecting uptime of wireless client
- TX Rate:** transmit rate of wireless client
- RX Rate:** receive rate of wireless client
- Signal:** the signal of wireless client
- Noise:** the noise of wireless client
- SNR:** the signal to noise ratio of wireless client
- Signal Quality:** signal quality of wireless client

Neighbor's Wireless Networks

SSID	Mode	MAC Address	Channel	Rssi	Noise	beacon	Open	dtim	Rate	Join Site
tzt-3g	Unknown	00:aa:bb:cc:dd:14	2	-5	-95	0	No	0	54(b/g)	Join
four-faith	Unknown	00:0c:43:30:52:79	6	-24	-95	0	No	0	300(b/g/n)	Join
ff-old	AP	00:13:10:09:56:92	6	-55	-95	0	No	0	54(b/g)	Join

- Neighbor's Wireless Network:** display other networks nearby
- SSID:** the name of wireless network nearby
- Mode:** operating mode of wireless network nearby
- MAC Address:** MAC address of the wireless nearby
- Channel:** the channel of the wireless nearby
- Rssi:** signal intensity of the wireless nearby
- Noise:** the noise of the wireless nearby
- Beacon:** signal beacon of the wireless nearby
- Open:** the wireless nearby is open or not
- Dtim:** delivery traffic indication message of the wireless nearby
- Rate:** speed rate of the wireless nearby
- Join Site:** click to join wireless network nearby

3.3.11.5 Bandwidth



Bandwidth Monitoring-LAN Graph

abscissa axis: time

vertical axis: speed rate

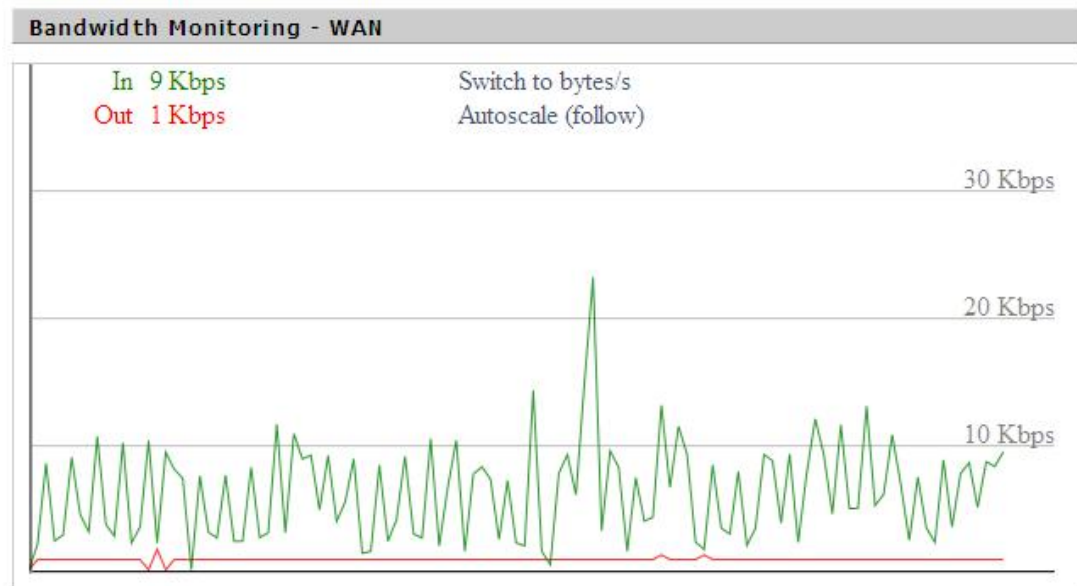

Bandwidth Monitoring-WAN Graph

abscissa axis: time

vertical axis: speed rate

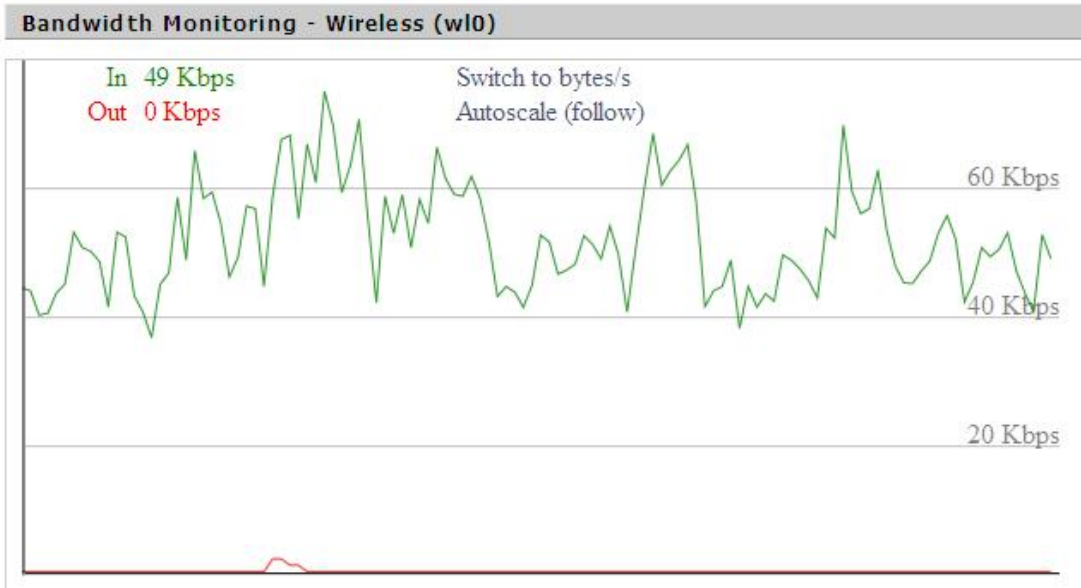

Bandwidth Monitoring-Wireless (W10) Graph

abscissa axis: time

vertical axis: speed rate

3.3.11.6 Sys-Info

Router	
Router Name	Four-Faith
Router Model	Four-Faith Router
LAN MAC	<u>00:0C:43:30:52:77</u>
WAN MAC	<u>00:0C:43:30:52:78</u>
Wireless MAC	<u>00:0C:43:30:52:79</u>
WAN IP	10.34.107.156
LAN IP	192.168.1.1

Router Name: the name of the router

Router Model: the model of the router

LAN MAC: MAC address of LAN port

WAN MAC: MAC address of WAN port

Wireless MAC: MAC address of the wireless

WAN IP: IP address of WAN port

LAN IP: IP address of LAN port

Wireless	
Radio	Radio is On
Mode	AP
Network	Mixed
SSID	four-faith
Channel	6 (2437 MHz)
TX Power	71 mW
Rate	72 Mb/s

Radio: display whether radio is on or not

Mode: wireless mode

Network: wireless network mode

SSID: wireless network name

Channel: wireless network channel

TX Power: reflection power of wireless network

Rate: reflection rate of wireless network

Wireless Packet Info	
Received (RX)	6982 OK, no error
Transmitted (TX)	1498 OK, no error

Received (RX): received data packet

Transmitted (TX): transmitted data packet

Wireless								
Clients								
MAC Address	Interface	Uptime	TX Rate	RX Rate	Signal	Noise	SNR	Signal Quality
- None -								

MAC Address: MAC address of wireless client

Interface: interface of wireless client

Uptime: connecting uptime of wireless client

TX Rate: transmit rate of wireless client

RX Rate: receive rate of wireless client

Signal: the signal of wireless client

Noise: the noise of wireless client

SNR: the signal to noise ratio of wireless client

Signal Quality: signal quality of wireless client

Services

DHCP Server	Enabled
ff-radauth	Disabled
USB Support	Disabled

DHCP Server: enabled or disabled

ff-radauth: enabled or disabled

USB Support: enabled or disabled

Memory

Total Available	122.3 MB / 128.0 MB
Free	92.6 MB / 122.3 MB
Used	29.6 MB / 122.3 MB
Buffers	3.3 MB / 29.6 MB
Cached	11.7 MB / 29.6 MB
Active	10.3 MB / 29.6 MB
Inactive	6.4 MB / 29.6 MB

Total Available: the room for total available of RAM (that is physical memory minus some reserve and the kernel of binary code bytes)

Free: free memory, the router will reboot if the memory is less than 500kB

Used: used memory, total available memory minus free memory

Buffers: used memory for buffers, total available memory minus allocated memory

Cached: the memory used by high-speed cache memory

Active: Active use of buffer or cache memory page file size

Inactive: Not often used in a buffer or cache memory page file size

DHCP

DHCP Clients

Host Name	IP Address	MAC Address	Expires
*	192.168.1.143	xx:xx:xx:xx:DD:45	1 day 00:00:00
four-488e1df5fa	192.168.1.125	xx:xx:xx:xx:D8:F7	1 day 00:00:00
Mycenae-PC	192.168.1.116	xx:xx:xx:xx:5E:30	1 day 00:00:00

Host Name: host name of LAN client

IP Address: IP address of the client

MAC Address: MAC address of the client

Expires: the expiry the client rents the IP address

Appendix

The following steps describe how to setup Windows XP Hyper Terminal.

1. Press “Start”→”Programs”→”Accessories”→”Communications”→”Hyper Terminal”



2. Input connection name, choose “OK”
3. Choose the correct COM port which connects to modem, choose “OK”



4. Configure the serial port parameters as following, choose “OK”

Bits per second: 115200

Data bits: 8

Parity: None

Stop bits: 1

Flow control: None

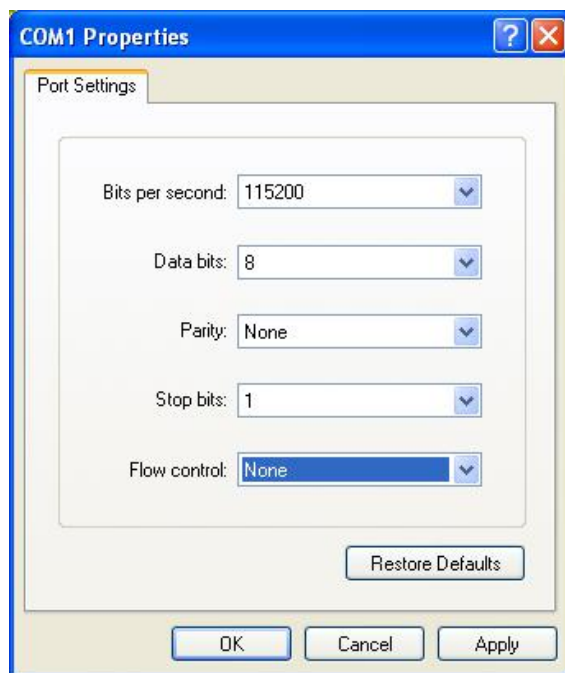

5. Complete Hyper Terminal operation, It runs as following

